

Masszeichnung

Kühltisch (2 Abteile) KTZ 2-76-2T I FL (zentralgekuehlt)

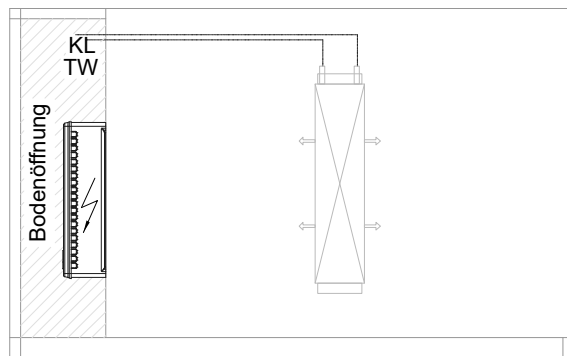
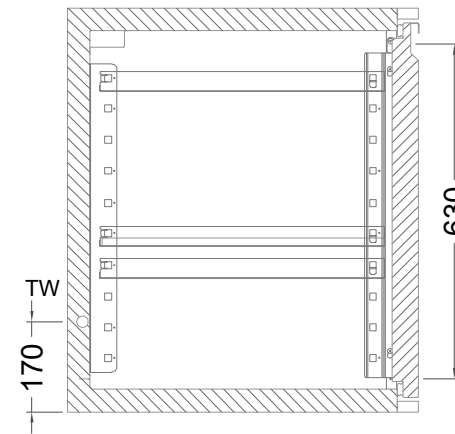
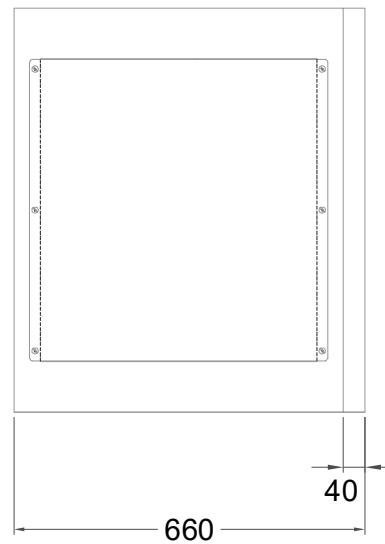
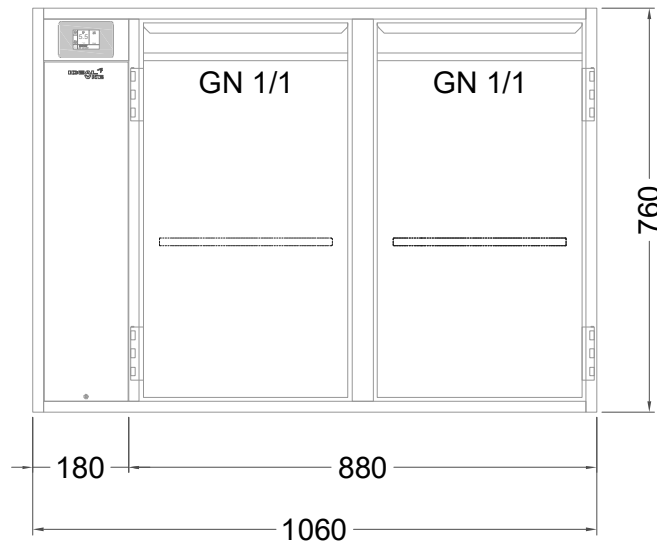

[Art.Nr.: 31000635]

KTZ 2-76-2T

- * KL...Kälteleitungen
- * TW...Tauwasser - bauseitiger Siphon und Ablauf erforderlich
- * ⚡ Verdrahtung bis Klemmkasten

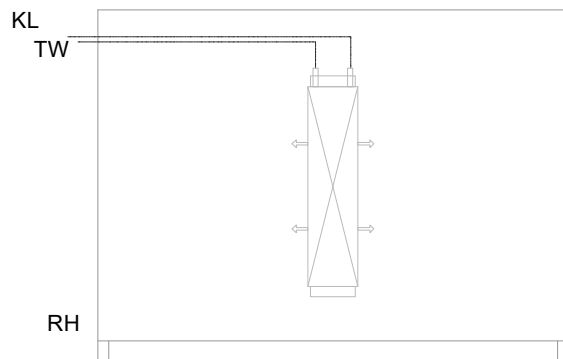
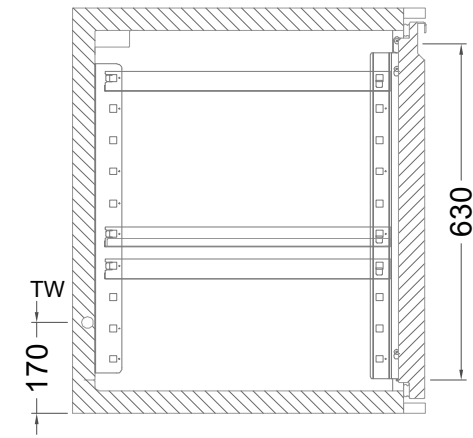
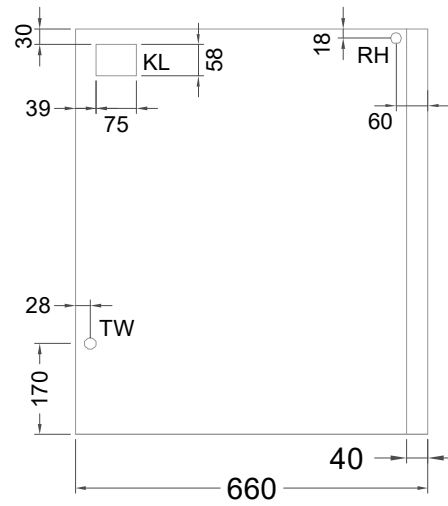
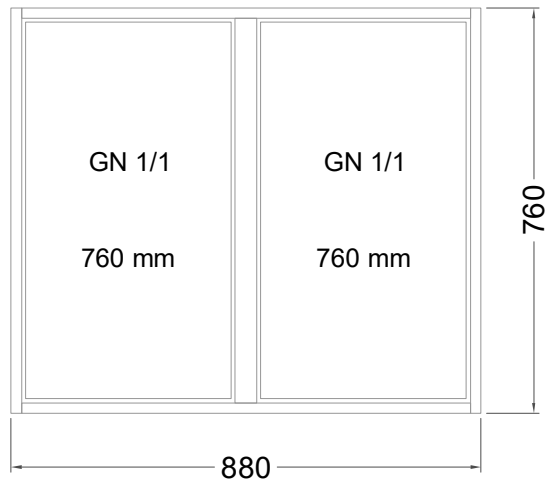

KT 2-76-xx

- * KL...Kälteleitungen
- * TW...Tauwasser - Siphon und bauseitiger Ablauf erforderlich
- * RH...Rahmenheizung

Details IDEAL-AKE Kälteregele

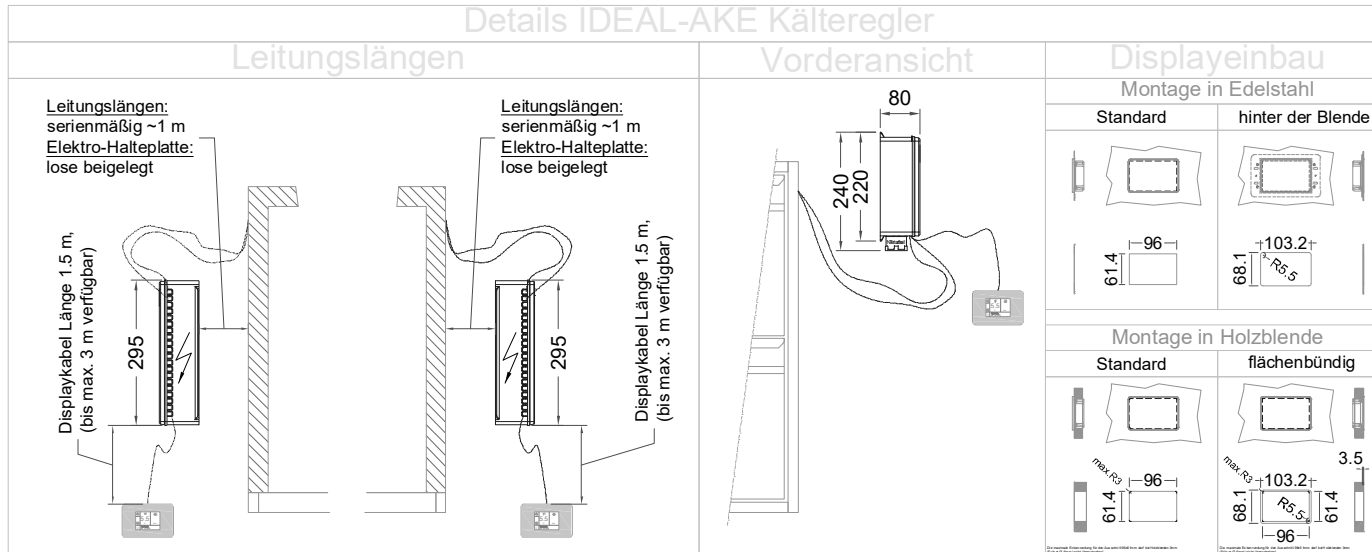

Türelement

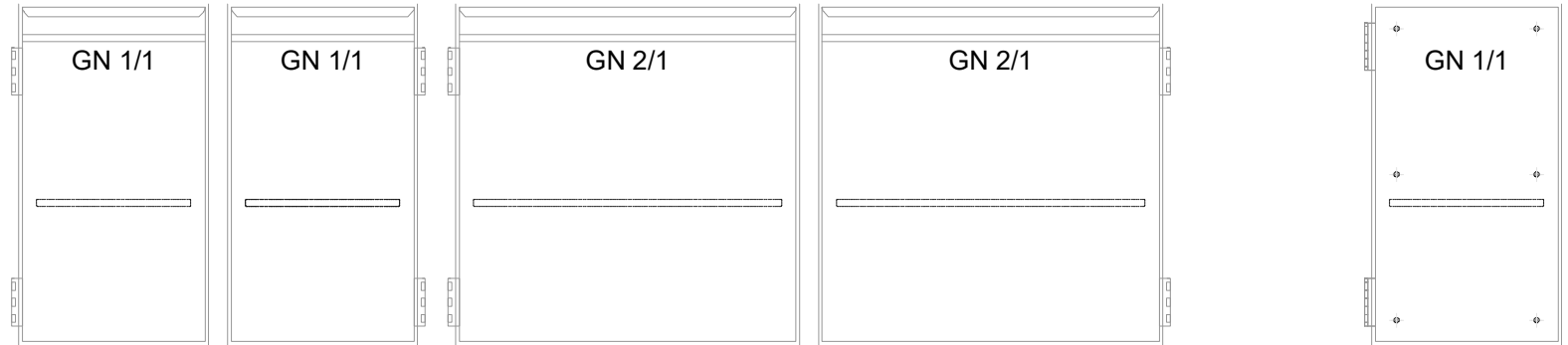
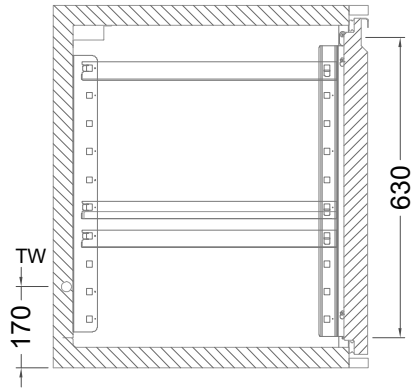

2 Züge 1/2-1/2

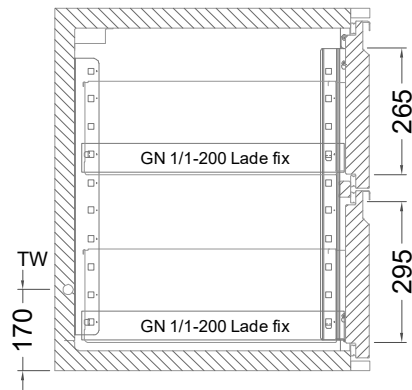

2 Züge FL (Flaschenlade)

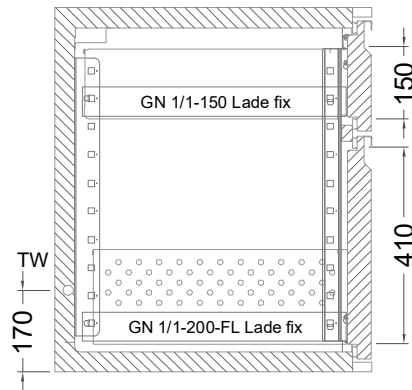

3 Züge 3x1/3

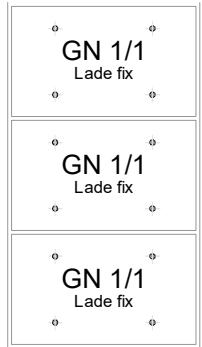
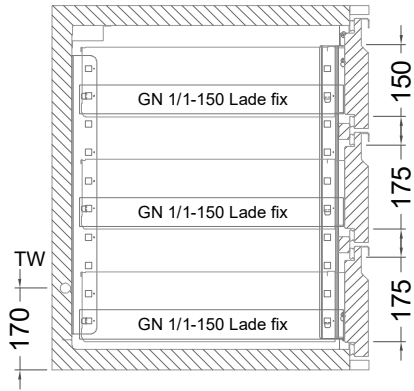

2 Züge 1/2-1/2 mit herausnehmbaren Ladeneinsätzen

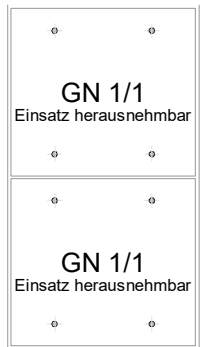
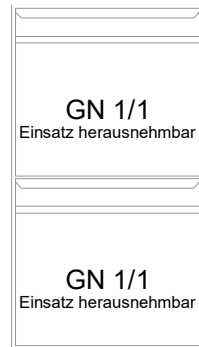
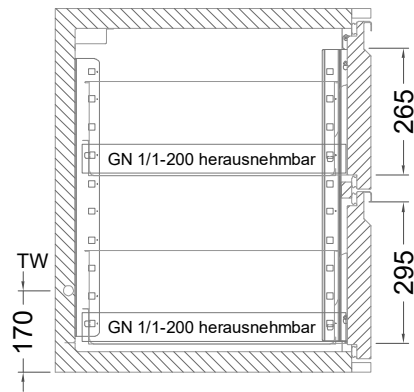

3 Züge 3x1/3 mit herausnehmbaren Ladeneinsätzen

