

Ersatzteilliste-Explosionszeichnung Kühltisch (4 Abteile) CRI O HPO 700



**HORIZONTAL COUNTERS
TAVOLI ORIZZONTALI**

**ECOSTORE h700
Remote left side cooling connections**

Type reference	Ref	Page	Description	Brand
H7NTN2R	a	3-11,13-15,17	Counter 2 compartments refrigerated remote HP	all
H7NTN3R	b	3-11,13-15,17	Counter 3 compartments refrigerated remote HP	all
H7NTN4R	c	3-11,13-15,17	Counter 4 compartments refrigerated remote HP	all
H7NBT2R	d	3-11,13-17	Counter 2 compartments freezer remote HP & CL	all
H7NBT3R	e	3-11,13-17	Counter 3 compartments freezer remote HP & CL	all
H7NTN2RC	f	3-10,12-15,17	Counter 2 comp. refrigerated remote HP CO2 with valve	all
H7NTN3RC	g	3-10,12-15,17	Counter 3 comp. refrigerated remote HP CO2 with valve	all
H7NTN4RC	h	3-10,12-15,17	Counter 4 comp. refrigerated remote HP CO2 with valve	all
H7NBT2RC	i	3-10,12-15,17	Counter 2 comp. freezer remote HP CO2 with valve	all
H7NBT3RC	l	3-10,12-15,17	Counter 3 comp. freezer remote HP CO2 with valve	all

Index	Page
Identification Type Ref./Identificazione type Ref.	2
Body module/corpo armadio	3
Spare part list/Lista ricambi	4
Door and drawers/ Porte e cassette	5,6,7
Spare part list/Lista ricambi	8
Top/Ripiano	9
Spare part list/Lista ricambi	10
Remote cooling unit Refrig. & Freezer/Gruppo remoto Refrigerato & Freezer	11
Remote cooling unit Refrig. & Freezer CO2 with valve/Gruppo remoto Refrigerato & Freezer CO2 con valvola	12
Spare part list/Lista ricambi	13-14
Control panel/Pannello di controllo	15-16
Spare part list/Lista ricambi	17

...Bold= last change/Grassetto =ultima modifica

* HP =High performance

* CL = Concept line

Rev. 4

From Ser. Nr.... Up to Ser. Nr....	Ed. 2017/06/01 Updated 2023/07	Page: 1	Doc No:595R32200
---------------------------------------	-----------------------------------	---------	-------------------------

How to put in relation the “Type Ref.” reported on the data plate with the “Type reference” reported on the front page of the Spare Part Catalogue:

The “Type Ref.” represents a group of models/brands all with similar technical features, hence possible to be reported under the same scheme in terms of exploded views.

Find below an identification example: **H7NTN2BHC**

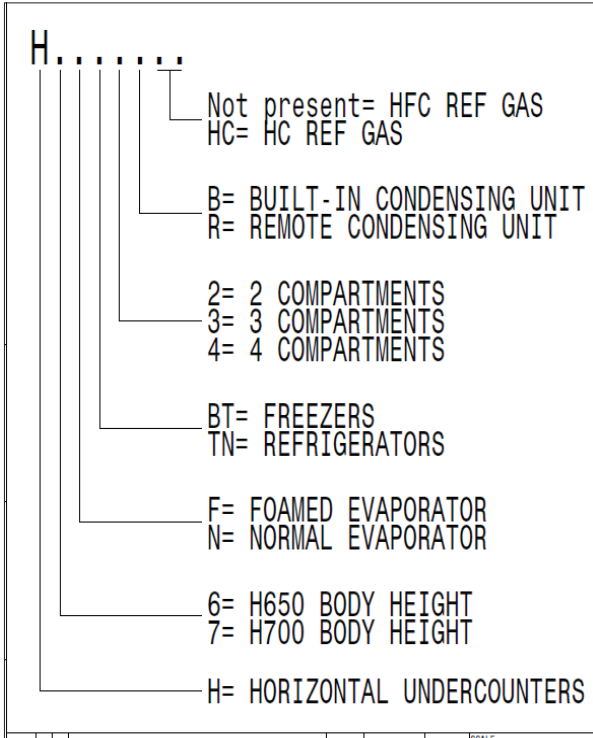

F. Mod. EH2H7AA	Comm. Mod. EH2H7AA	Type Ref. H7NTN2BHC	2017
PNC 9VTX 710000 00	Ser. No. 70810001	Cyclopentane	
W Tot. 0.25 kW	Volt 220-240 V	1 ~ 50 Hz	Total Current 1.9 A
Potenza Sbrinamento / Defrost Power	0.29 kW	Classe/Class 5	GWP 3 CO2-eq 0 t
Resistenza Evaporazione/Evaporation Heater El.	kW	Refrigerante / Refrigerant R290	0,07 kg.
Illuminazione / Lighting	W	Cap. 240	MADE IN ITALY
NF nominal Charge			
Rated Pressure	MPa		
IP21			
Electrolux Professional SpA - Viale Treviso, 15 - 33170 Pordenone (Italy)			

For the right spare code identification follow the steps:

1. type in the website the PNC reported on the data plate.
2. The website will automatically display this spare part catalogue.
3. The spare part code at this point is referenced through the “Type reference” as from the front page by the relevant “Ref”.

Come mettere in relazione il “Type Ref.” Riportato sulla targhetta caratteristica con il “Type reference” riportato sul frontespizio del catalogo ricambi:

Il “Type Ref.” Rappresenta un gruppo di modelli/marchi con simili caratteristiche tecniche, ossia possibili da rappresentare con il medesimo schema in termini di vista esplosa.

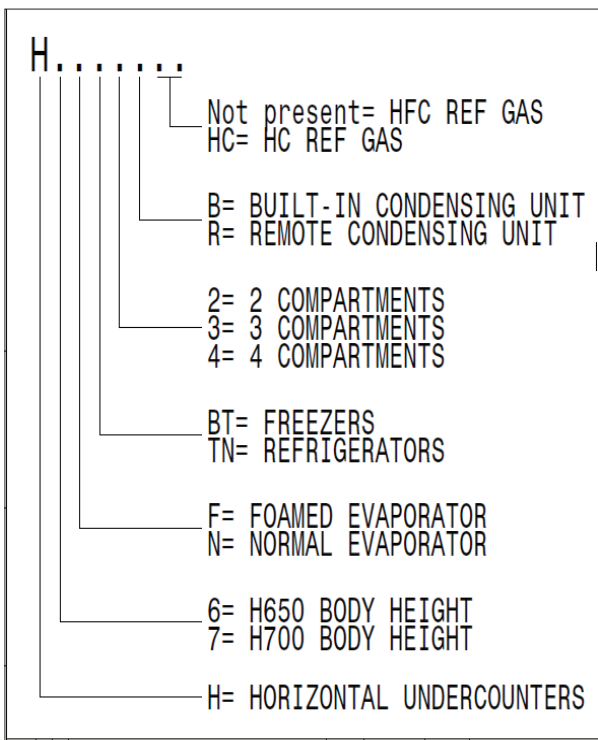

Qui di seguito un esempio di identificazione: **H7NTN2BHC**

F. Mod. EH2H7AA	Comm. Mod. EH2H7AA	Type Ref. H7NTN2BHC	2017
PNC 9VTX 710000 00	Ser. No. 70810001	Cyclopentane	
W Tot. 0.25 kW	Volt 220-240 V	1 ~ 50 Hz	Total Current 1.9 A
Potenza Sbrinamento / Defrost Power	0.29 kW	Classe/Class 5	GWP 3 CO2-eq 0 t
Resistenza Evaporazione/Evaporation Heater El.	kW	Refrigerante / Refrigerant R290	0,07 kg.
Illuminazione / Lighting	W	Cap. 240	MADE IN ITALY
NF nominal Charge			
Rated Pressure	MPa		
IP21			
Electrolux Professional SpA - Viale Treviso, 15 - 33170 Pordenone (Italy)			

Per identificare il corretto codice ricambio procedere con:

1. Digitare nel website il PNC riportato sulla targhetta caratteristica.
2. Il website mostrerà automaticamente questo catalogo ricambi.
3. A questo punto, il codice ricambio è identificabile attraverso il “Type reference” come indicato nel frontespizio sotto la relativa voce “Ref”.

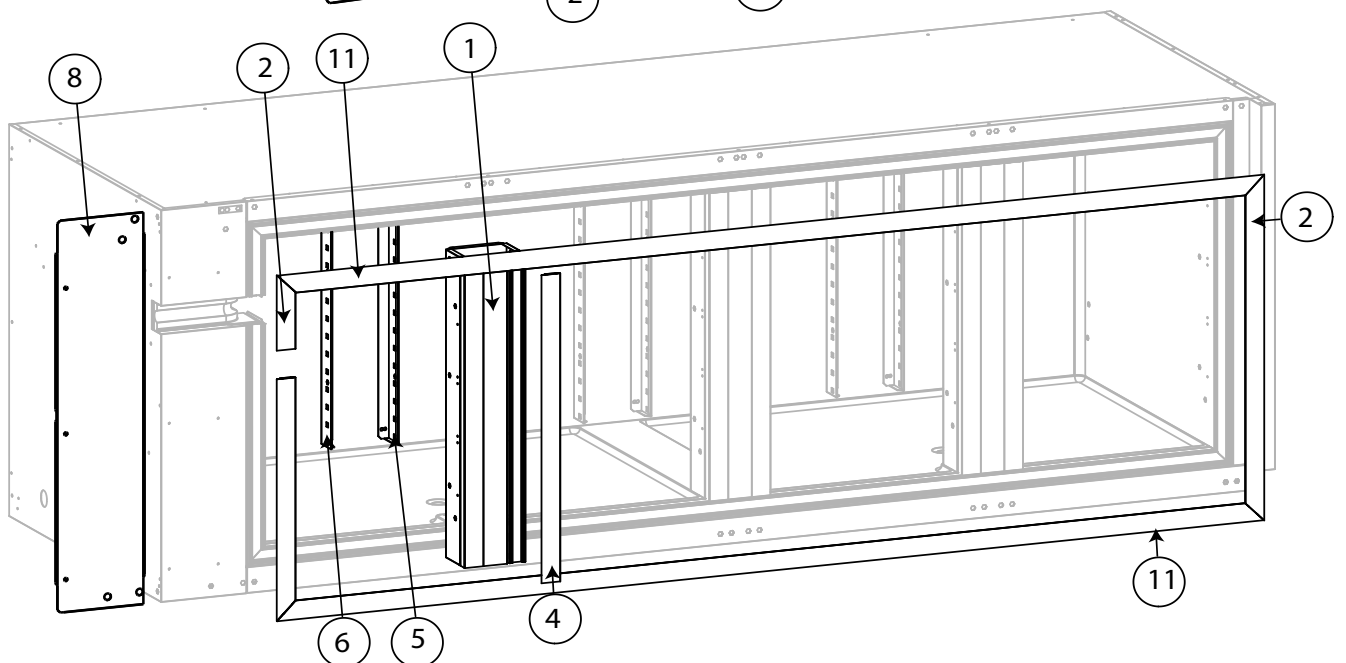
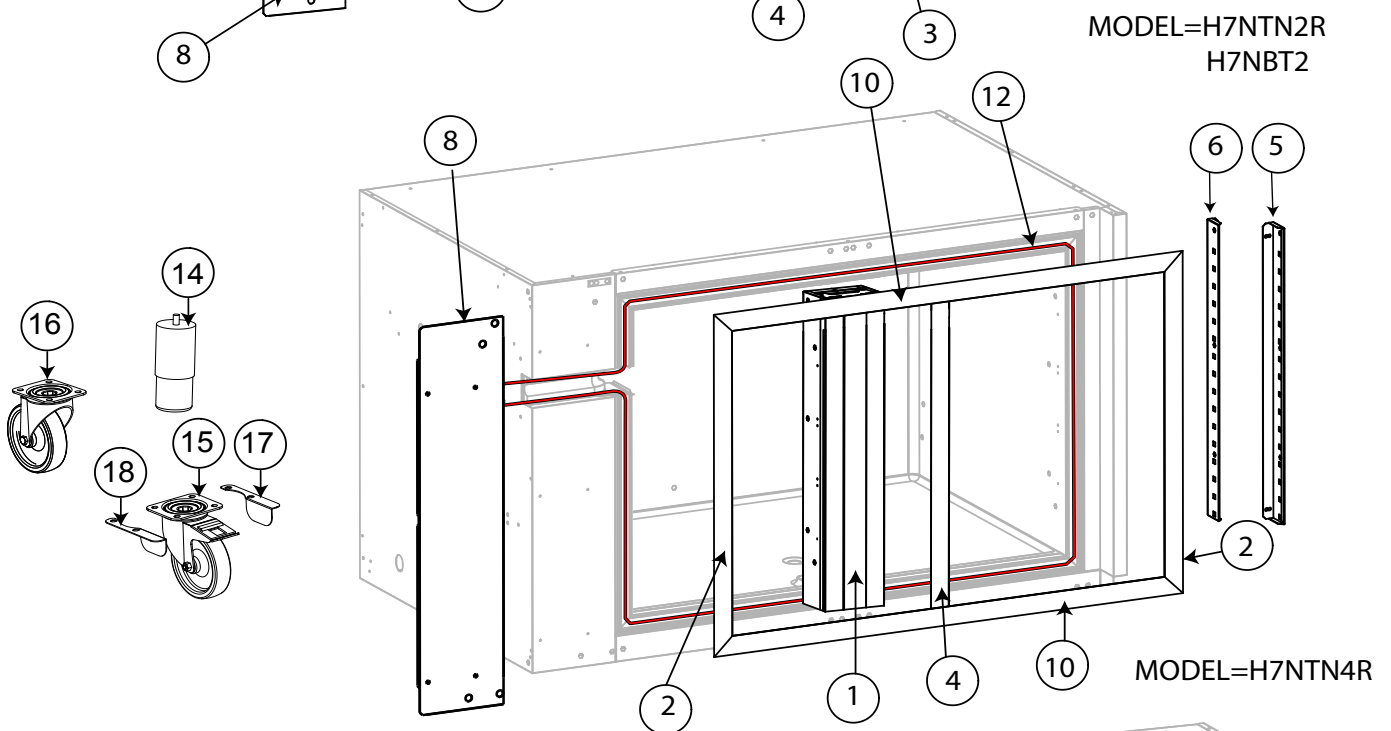
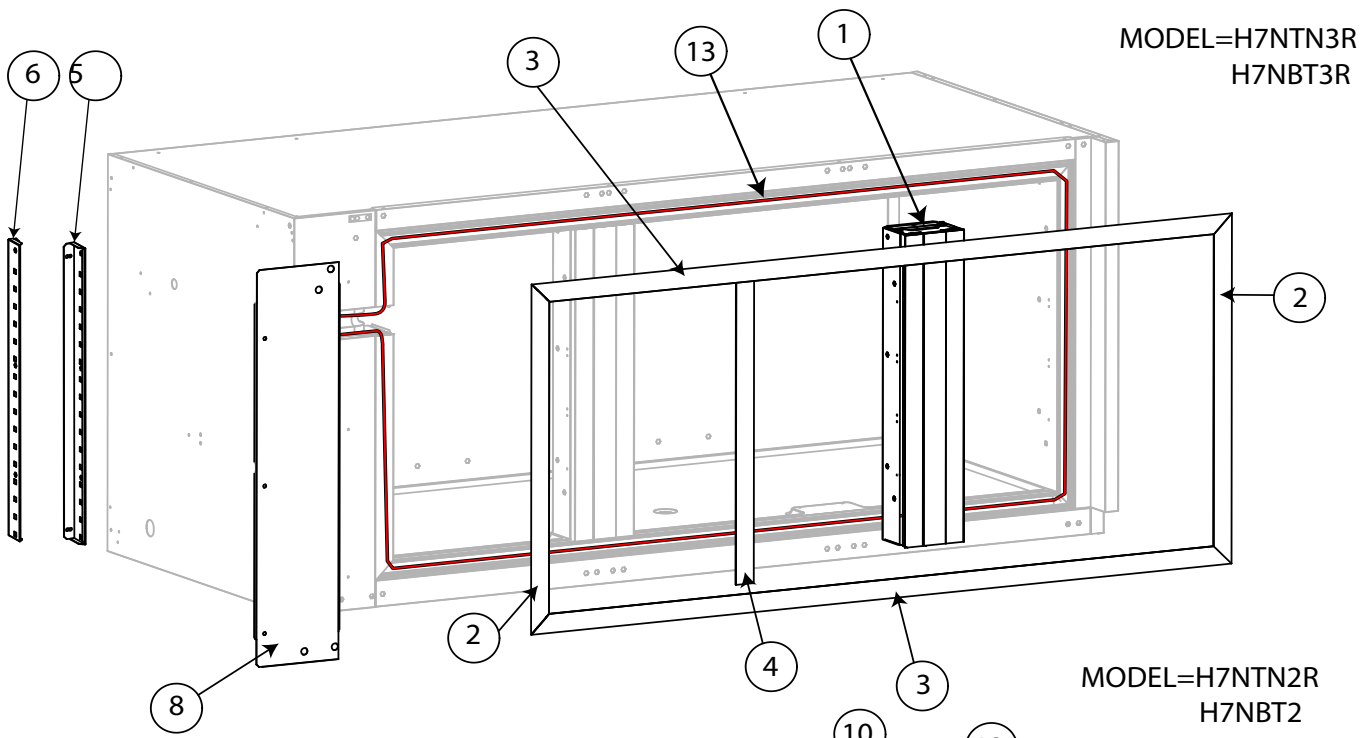

HORIZONTAL COUNTERS REMOTE				ECOSTORE HP & CL 700	
Pos	Code	Factory code	Description	Descrizione	Ref/notes
Reference pag.3					
Body Assembly			Corpo schiumato		
1	095337	835R54002	FOAMED VERTICAL PILLAR ASSEMBLED	MONTANTE ASSEMBLATO	a,b,c up to 9131
1	096522	835R67901	FOAMED VERTICAL PILLAR ASSEMBLED	MONTANTE ASSEMBLATO	a,b,c,f,g,h from 9141 d,e,i,l from 9391
1	095345	835R56401	FOAMED VERTICAL PILLAR ASSEMBLED	MONTANTE ASSEMBLATO	d,e up to 9131
1		835R68101	FOAMED VERTICAL PILLAR ASSEMBLED	MONTANTE ASSEMBLATO	d,e,i,l from 9141 up to 9381
2	095236	543R16400	VERTICAL FRAME COVER	COPERCHIO CORN.VERT. TAV 2/3/4V	a,b,c,f,g,h
2	095346	543R19801	VERTICAL FRAME COVER	COPERCHIO CORN.VERT. TAV 2V BT	d,e,i,l
3	095246	543R16600	HORIZONTAL FRAME COVER <u>refriger.</u>	COPERCHIO CORN ORIZZ TAV 3V TN	b,g
3	095253	543R19500	HORIZONTAL FRAME COVER <u>freezer</u>	COPERCHIO CORN ORIZZ TAV 3V BT	e,i
4	095338	543R17701	VERTICAL FRAME FOR PILLAR	CORNICE VERTICALE MONTANTE	a,b,c,f,g,h
4	095347	543R19700	VERTICAL FRAME FOR PILLAR	CORNICE VERTICALE MONTANTE	d,e,i,l
5	095321	503R16702	REAR RIGHT SUPPORT GRIDS H700	SUPPORTO POSTERIORE DX	
6	095322	502R84504	REAR LEFT SUPPORT GRIDS H700	SUPPORTO POSTERIORE SX	
8	095358	503R40600	FRONT COVER PANEL SIDE (LEFT)	PANNELLO FRONTALE SX A304	
10	095226	543R16500	HORIZONTAL FRAME COVER	COPERCHIO CORN ORIZZ TAV 2V	a,f
10	095254	543R19400	HORIZONTAL FRAME COVER	COPERCHIO CORN ORIZZ TAV 2V	d,i
11	095255	543R16700	HORIZONTAL FRAME COVER	COPERCHIO CORN ORIZZ TAV 4V	c,f
12	093330	617R06701	FRAME HEATING CABLE 2V L 5450 mm	CAVO RISCALDANTE CORNICI 2V porte	d,i only door
12	095256	617R15600	FRAME HEATING CABLE 2V L 6700 mm	CAVO RISCALDANTE CORNICI 2V	d,i 1 door_2 1/2 draw.
12	095257	617R15900	FRAME HEATING CABLE 2V L 9140 mm	CAVO RISCALDANTE CORNICI 2V	d,i 6 1/3 draw.
12	095258	617R15700	FRAME HEATING CABLE 2V L 8320 mm	CAVO RISCALDANTE CORNICI 2V	d,i 2 1/2 draw._ 3 1/3 drawers
12	095259	617R15800	FRAME HEATING CABLE 2V L 7490 mm	CAVO RISCALDANTE CORNICI 2V	d,i 4 1/2 draw. 1Door_3 1/3 drawers
13	094096	617R09500	FRAME HEATING CABLE 3V L 8140 mm	CAVO RISCALDANTE CORNICI 3V	e,i only door
13	095260	617R16000	FRAME HEATING CABLE 3V L 8600 mm	CAVO RISCALDANTE CORNICI 3V	e,i 2 door_2 1/2 draw.
13	095261	617R16100	FRAME HEATING CABLE 3V L 9400 mm	CAVO RISCALDANTE CORNICI 3V	e,i 1 door_4 1/2 draw. 2 door_3 1/3 draw.
13	095262	617R16200	FRAME HEATING CABLE 3V L 10200 mm	CAVO RISCALDANTE CORNICI 3V	e,i 6 1/2 draw. 1 door_2 1/2 draw._3 1/3 dw.
13	095263	617R16300	FRAME HEATING CABLE 3V L12700 mm	CAVO RISCALDANTE CORNICI 3V	e,i 9 1/3 draw.
13	095264	617R16400	FRAME HEATING CABLE 3V L11030 mm	CAVO RISCALDANTE CORNICI 3V	e,i 1 door_6 1/3 draw. 4 1/2 draw._ 3 1/3 drawers
13	095265	617R16500	FRAME HEATING CABLE 3V L11850 mm	CAVO RISCALDANTE CORNICI 3V	e,i 2 1/2 draw._ 6 1/3 drawers
14	091610	0518R01100	FOOT H 150 WITH CENTRAL SCREW	PIEDE VITE CENT.+ RIVEST.INOX H150	
15	087110	0835739900	WHEEL WITH BRAKE	RUOTA A PIASTRA ROT. CON FRENO	
16	087111	0835740000	WHEEL WITH-OUT BRAKE	RUOTA A PIASTRA ROT. SENZ. FRENO	
17	095324	0503R38501	RIGHT WHEEL LEVER BRAKE	FERMO RUOTA DESTRO	
18	095325	0503R38601	LEFT WHEEL LEVER BRAKE	FERMO RUOTA SINISTRO	
19					
20					
21					

881R40103
881R57901
881R75100
881R75000

APX/ZAN H700 DOOR

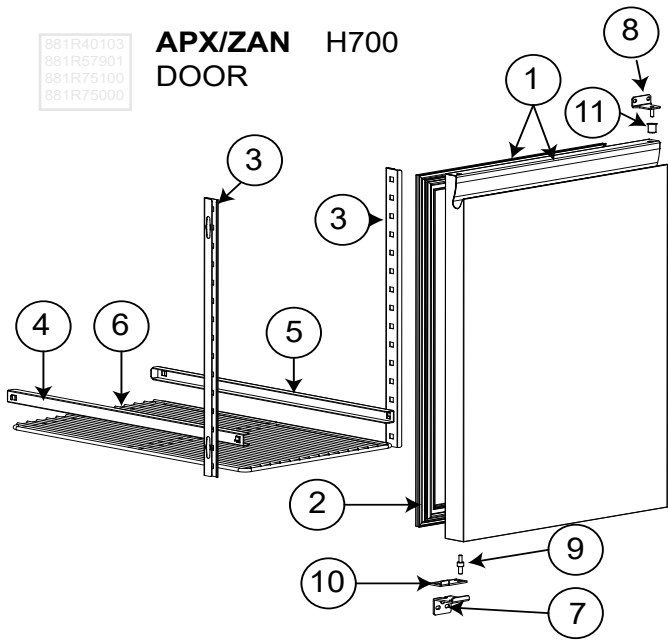

881R53002
881R74500
881R57800
881R74400

ELUX H700 DOOR

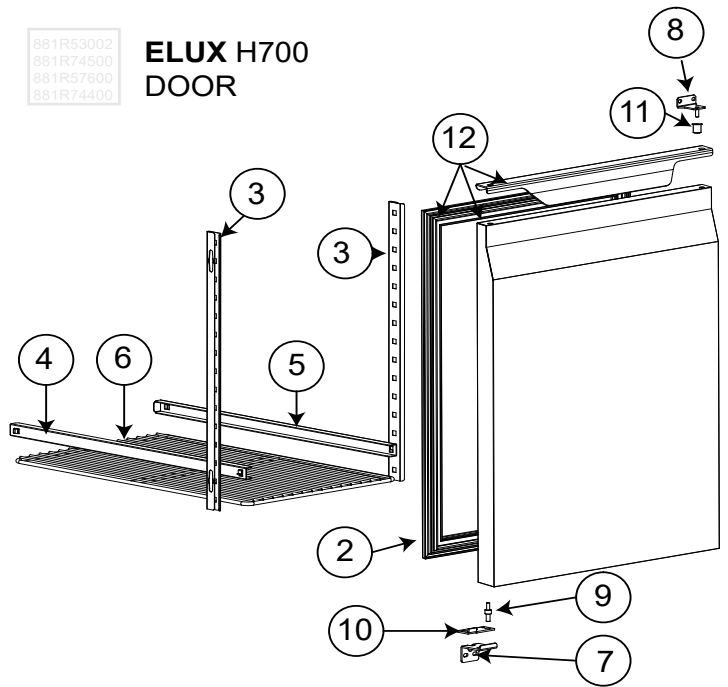

1/3 HOLLOW DRAWERS

APX/ZAN H700 DRAW 1/3

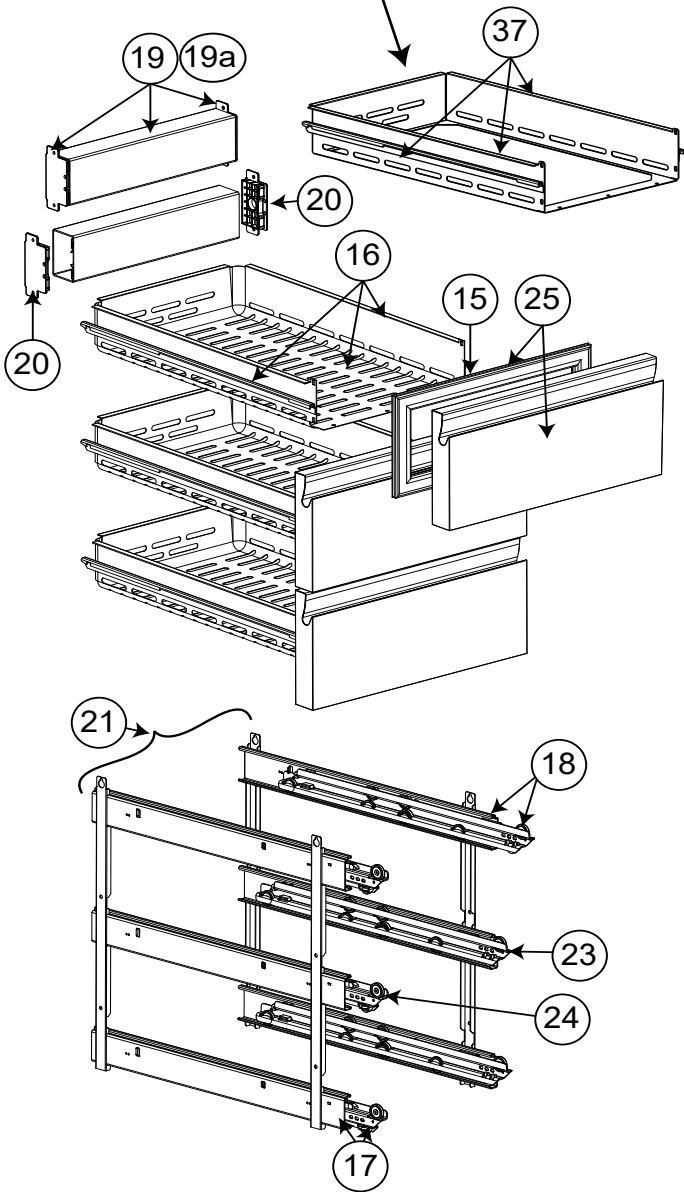

881R57001
881R77000

ELUX H700 DRAW. 1/3

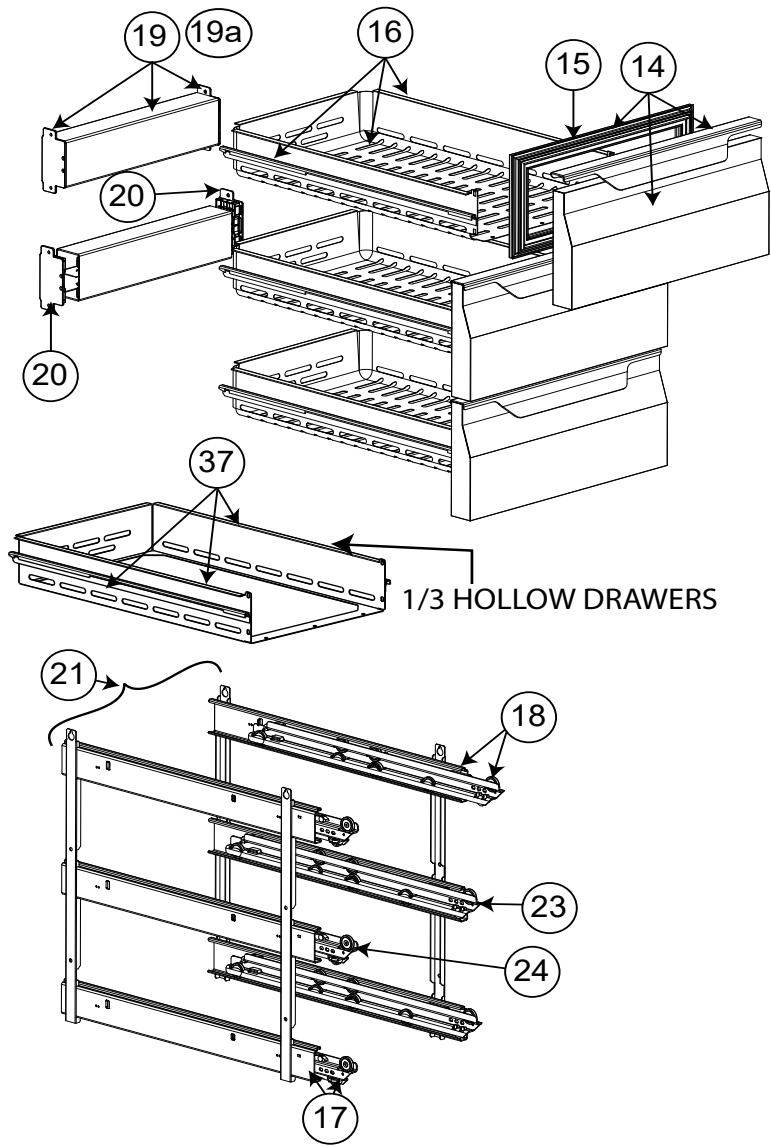

ELUX H700
DRAW. 1/2

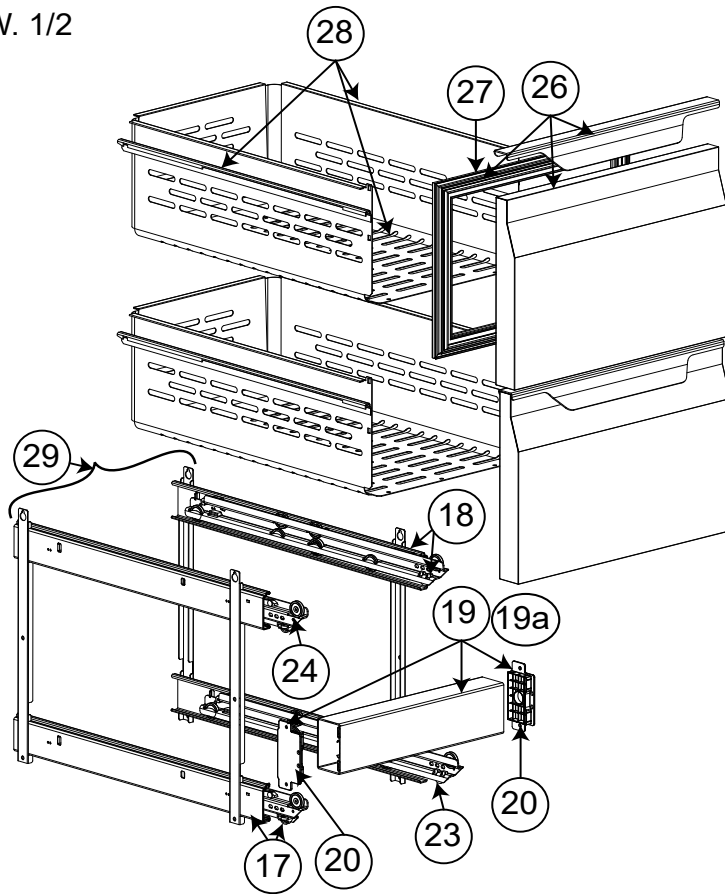

1/2 HOLLOW DRAWERS

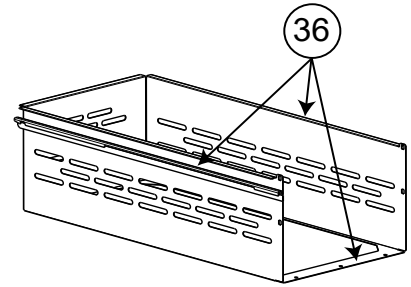

881R57501
881R77500

APX/ZAN H700
DRAW.1/2

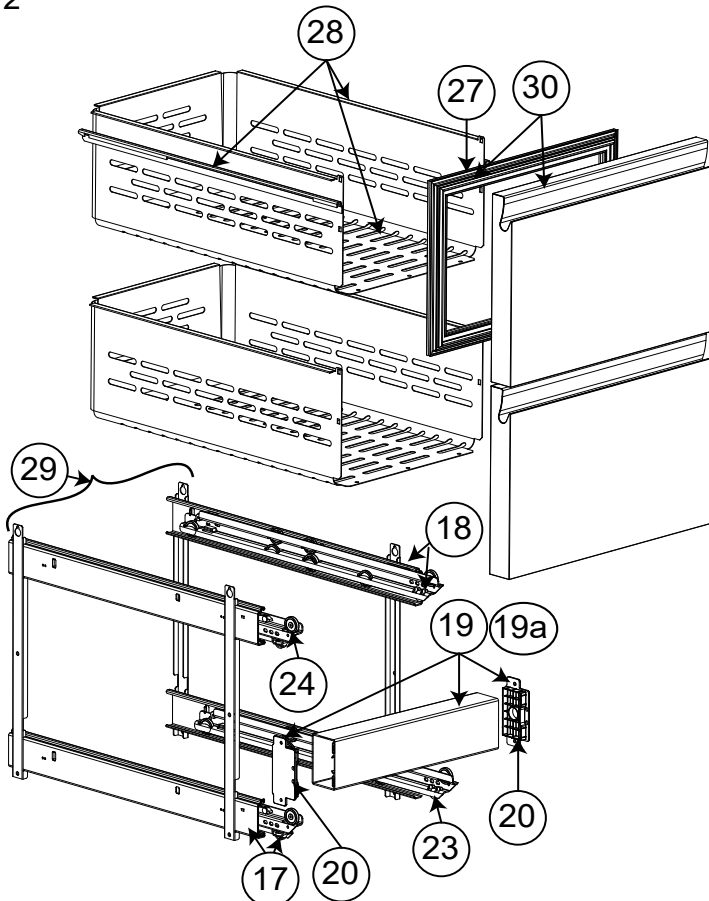

1/2 HOLLOW DRAWERS

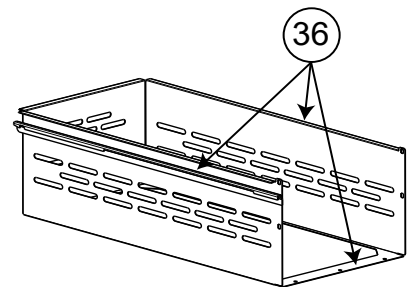

881R57801
881R77600

ELUX H700
BOTTLE DRAW.

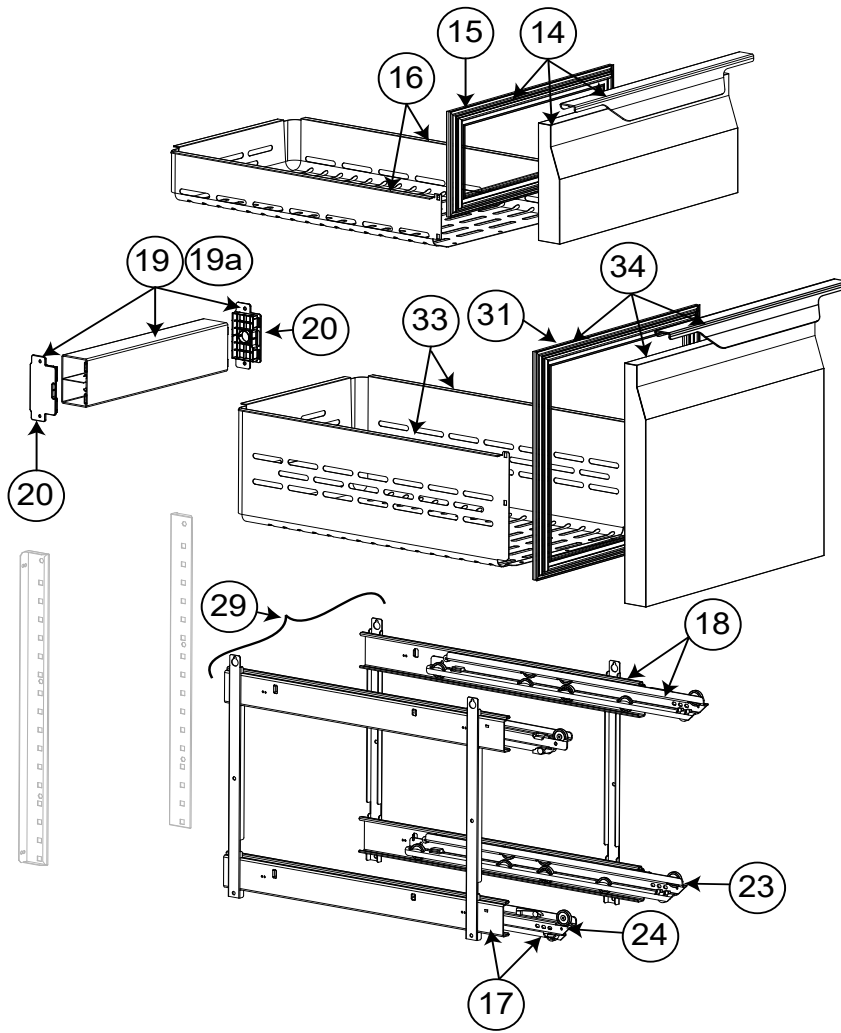

881R70800

APX/ZAN H700
BOTTLE DRAW.

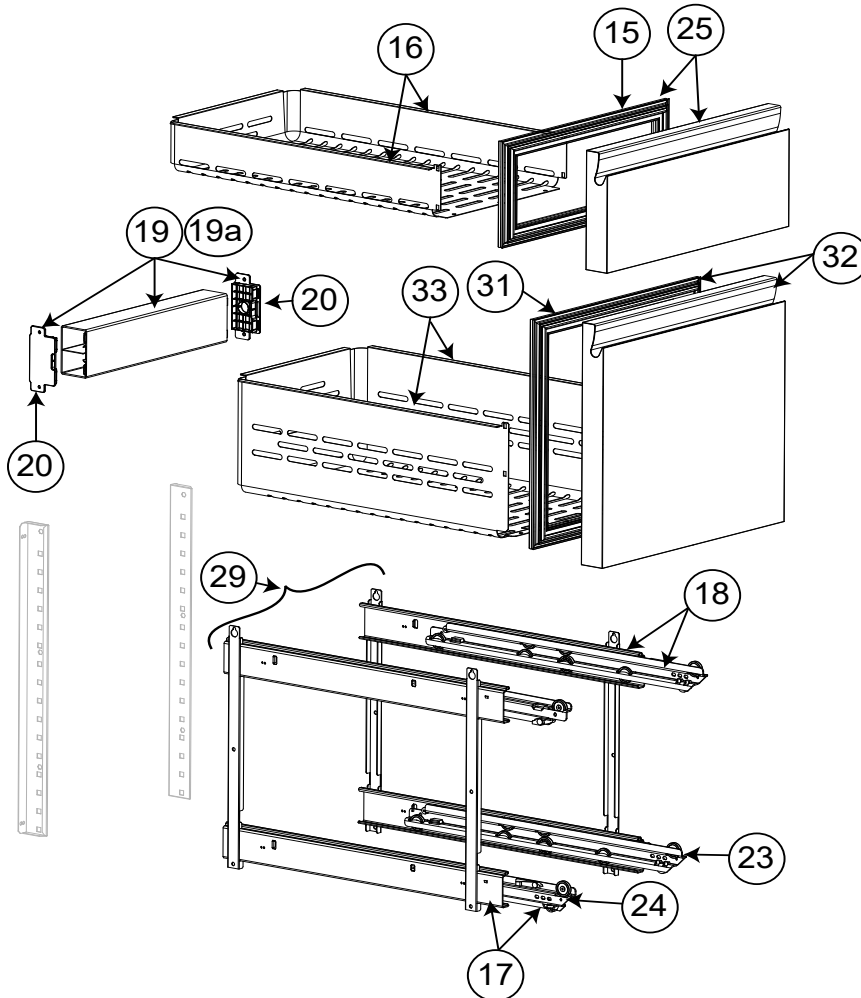

881R70700

HORIZONTAL COUNTERS REMOTE				ECOSTORE HP & CL 700	
Pos	Code	Factory code	Description	Descrizione	Ref/notes
reference pag. 5-6-7					
Doors and Drawers			Porta e Cassetti		
1	095802	835R52104	FOAMED D. ASSEMBLY H700 apx/zan	PORTA SCHIU. CON GUARNI.APX_ZAN	brand Apx_Zan
2	095238	548R11101	A886 MAGNETIC GASKET H700	GUARNIZIONE PORTA	
3	095227	503R09701	FRONT SUPPORT GRIDS H700	FRONTALE SUPPORTO GUIDE	
4	095228	502R84601	LEFT GUIDE FOR SHELF	GUIDA A "C" SX TAV NGC H700/H650	
5	095229	502R84701	RIGHT GUIDE FOR SHELF	GUIDA A "C" DX TAV NGC H700/H650	
6	095231	514R23500	SHELF	GRIGLIA RILSAN TAVOLO H650/H700	
7	095326	505R23702	LOWER HINGE H650/H700	CERNIERA INFERIORE	
8	095327	505R23803	UPPER HINGE H650/H700	CERNIERA SUPERIORE	
9	087667	514746701	PIN FOR DOOR	PERNO PER CERNIERA INFERIORE	
10	089146	800735200	DOOR OPENING END COURSE	PIASTRINA FERMO BATTUTA PORTA	
11	081807	549700000	DOOR BUSH	BOCCOLA X CERNIERA	
12	095511	835R51907	FOAMED DOOR ASSEMBLY H700 EPR	PORTA CON GUARNIZIONE ELECTR.	brand: EPR
14	095512	835R53506	FOAMED DRAWERS 1/3 EPR	ASS.CASS.1/3 SCHIUM. TAVOLO ELEC	brand: EPR (+GASKET)
15	095240	548R11801	GASKET DRAWER 1/3	GUARNIZ.CASS.1/3 TAV NGC H700	
16		833R36002	1/3 DRAW+GUIDES (WITHOUT FRONTAL)	ASS.INVOLUCRO CASSETTO+GUIDE	
17	095266	832R23200	LEFT SUPPORT DRAWERS 1/3	CARRELLO SX PER MOD.CASSETTI	
18	095267	832R23300	RIGHT SUPPORT DRAWERS 1/3	CARRELLO DX PER MOD.CASSETTI	
19	095365	875R33501	CROSSBEAM ASSEMBLY - DRAWERS	TRAVERSA CASSETTO 1/ E 1/2 TN	only refrigerated Up to 2019/13
19	096130	835R70800	CROSSBEAM ASSEMBLY - DRAWERS	TRAVERSA CASSETTO TN	only refrigerated From 2019/14
19a	095366	835R53801	FOAM PILLAR ASS. - DRAWERS	TRAVERSA CASSETTO 1/ E 1/2 BT	only freezer
20	095552	543R18901	PLASTIC PILLAR PLUG RIGHT/LEFT	TAPPO TRAVERSA DX E SX	only refrigerated
21	095553	833R37202	1/3 SUPPORT +GUIDE ASSEMBLY	SUPPORTO TELAIO DX E SX CASS.1/3	
23	095267	832R23300	RIGHT SLIDING GUIDE	GUIDA SCORREVOLE DX	
24	095266	832R23200	LEFT SLIDING GUIDE	GUIDA SCORREVOLE SX	
25	095554	835R54205	FOAMED FRONT DRAW. 1/3 APX/ZAN	ASS.CASS.1/3 SCHIUMATO	brand Apx_Zan (+GASKET)
26	095822	835R54106	FOAMED FRONT DRAW. 1/2 EPR	ASS.CASS.1/2 SCHIUMATO ELEC	brand: EPR (+GASKET)
27	095239	548R11701	GASKET DRAWER 1/2	GUARNIZ.CASS.1/2 TAV NGC H700	
28	095814	833R35904	1/2 DRAW+GUIDES (WITHOUT FRONTAL)	INVOLUCRO CON GUIDE	
29	095555	833R37302	1/2-2/3 SUPPORT +GUIDE ASSEMBLY	SUPP. TELAIO DX E SX CASS.1/2-2/3	
30	095556	835R54305	FOAMED FRONT DRAW. 1/2 APX_ZAN	ASS.CASS.1/2 SCHIUM. ZAN_APX	brand Apx_Zan (+GASKET)
31	095249	548R12500	GASKET DRAWER 2/3	GUARNIZ.CASS.2/3 TAV NGC H700	
32	095557	835R57704	2/3 FOAM. FRONT DRAW. ASS. ALPEN	ASS.CASS.2/3 SCHIUM. ZAN_APX	brand Apx_Zan (+GASKET)
33	095558	833R38500	2/3 DRAW+GUIDES (WITHOUT FRONTAL)	ASS. INVOLUCRO CASS.+GUIDE 2/3	
34	095559	835R57505	2/3 FOAM.FRONT DRAW. ASS. EPR	ASS.CASS.2/3 SCHIUM. TAVOLO EPR	brand: EPR (+GASKET)
*	095300		INCLUDE N°23 AND N°24 (1RIGHT +1 LEFT)	INCLUDE N°23 E 24,(1+1 GUIDA DX-SX)	
36		833R39800	1/2 STOR. HOLLOW DRAW. GUIDES	ASS. INVOLUCRO CASS.+GUIDE	hollow draw 1/2
37		833R40100	1/3 STOR. HOLLOW DRAW. GUIDES	ASS. INVOLUCRO CASS.+GUIDE	hollow draw 1/3

MODEL=H7NTN4R

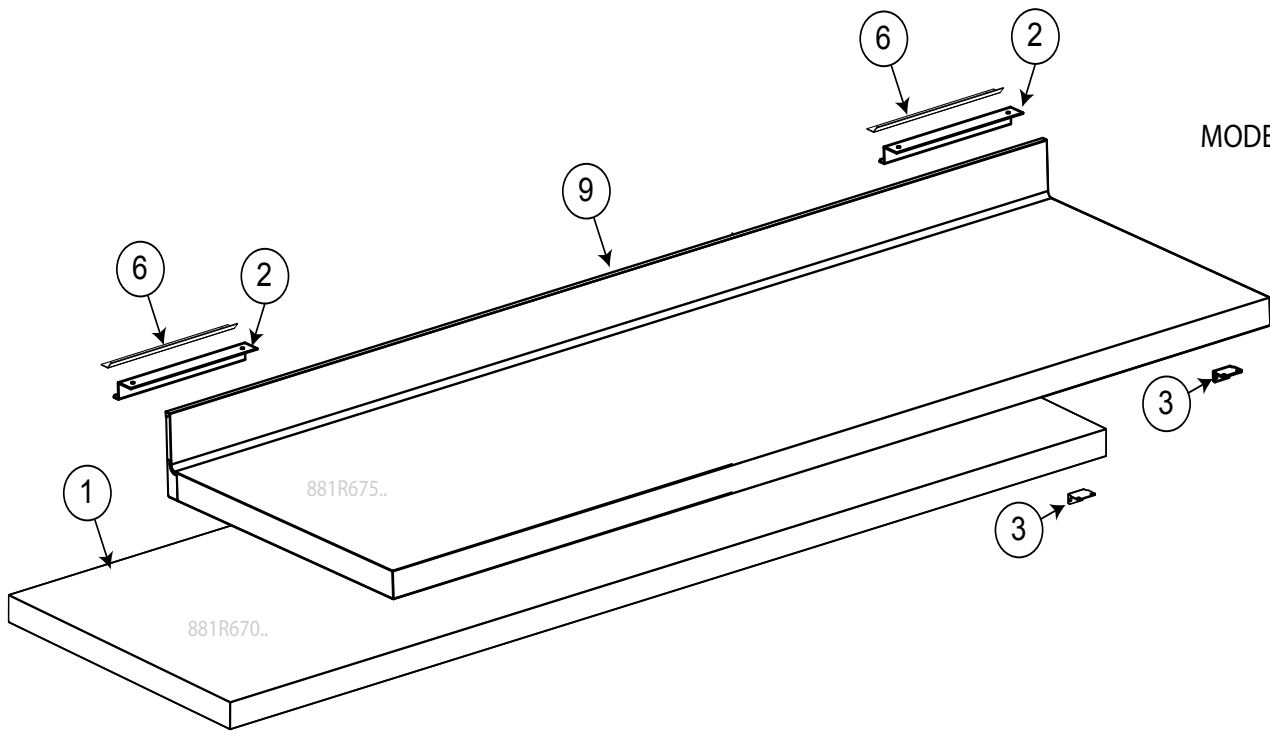

MODEL=H7NTN3R
H7NBT3R

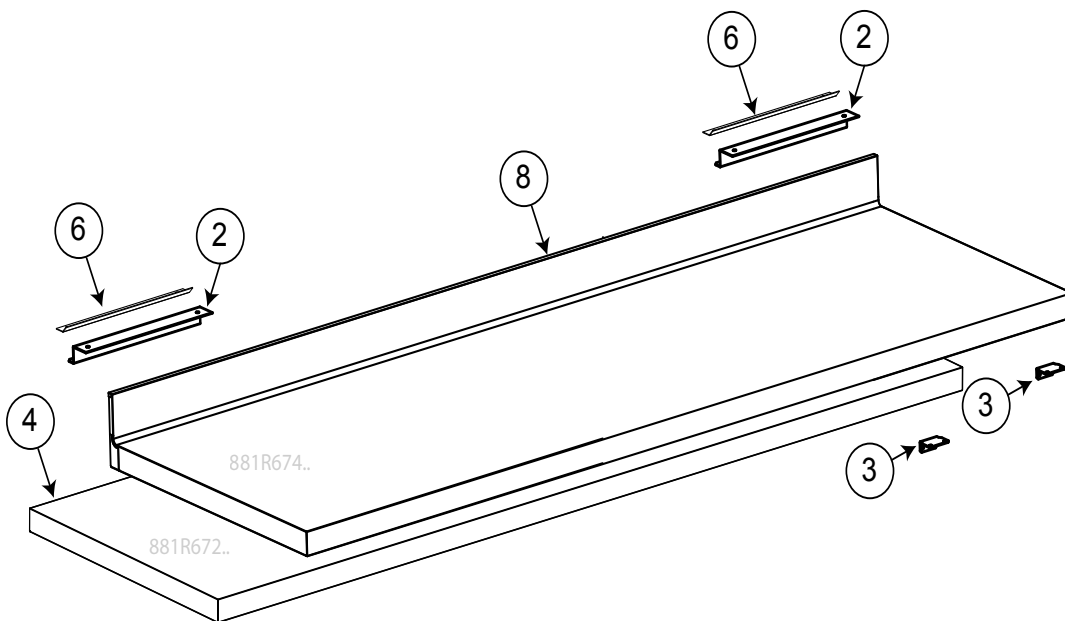

MODEL=H7NTN2R
H7NBT2R

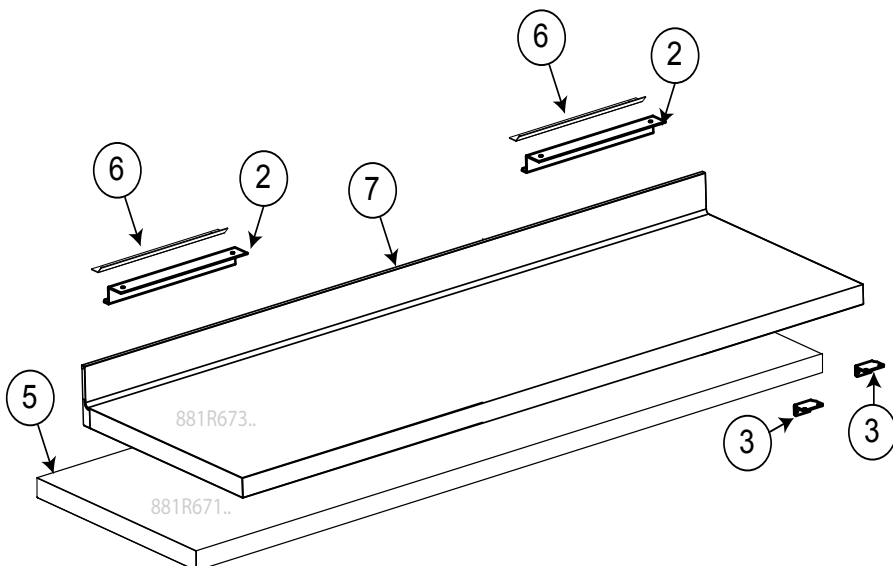

Pos	Code	Factory code	Description	Descrizione	Ref/notes
Reference pag.9					
			Worktop		Top
1		881R67001	WORKTOP MODULE 4C H50 "R-L"	TOP 4 VANI H 50 DX-SX	c,h (wihtout S.back)
2		501775700	HOOK FOR TOP	GANCIO PER RIPIANO	
3	095330	505R25301	BRACKET SHELF	STAFFA PER RIPIANO	
4		881R67201	WORKTOP MODULE 3C H50 "R-L"	TOP 3 VANI H 50 DX-SX	b,e,g,l (wihtout S.back)
5		881R67101	WORKTOP MODULE 2C H50 "R-L"	TOP 2 VANI H 50 DX-SX	a,d,f,i (wihtout S.back)
6	093186	505751500	HOOK FOR TOP ON THE COUNTER	FISSAGGIO RIPIANO AL TAVOLO	
7		881R67301	WORKTOP ASS. WITH 2C "R-L"	TOP CON ALZATINA 2 VANI DX-SX	a,d,f,i (whit S.back)
8		881R67401	WORKTOP ASSEMBLY 3C "R-L"	TOP CON ALZATINA 3 VANI DX-SX	b,e,g,l (whit S.back)
9		881R67501	WORKTOP ASS. WITH 4C "R-L"	TOP CON ALZATINA 4 VANI DX-SX	c,h (whit S.back)
10					
11					
12					
13					
14					
15					
16					
17					
18					
19					
20					
21					
22					
23					
24					

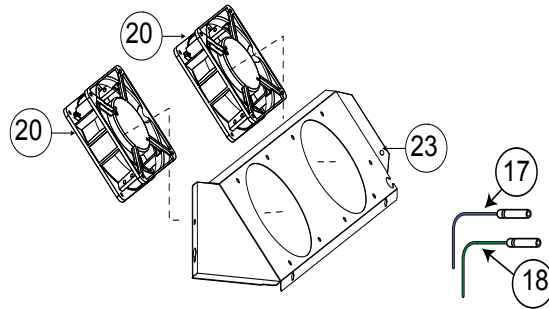
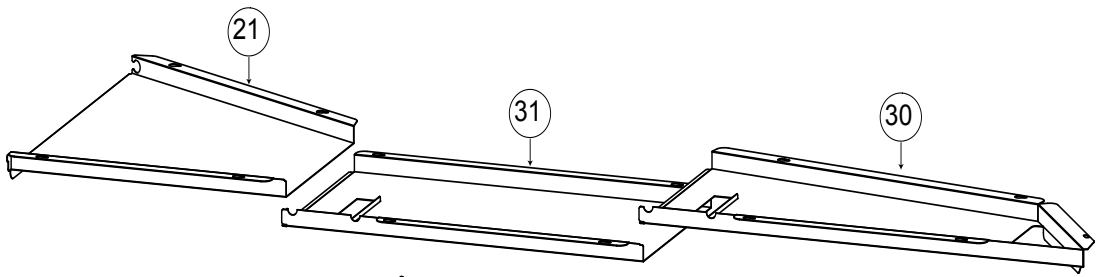

REFRIGERATED
model:
H7NTN2R
H7NTN3R
H7NTN4R

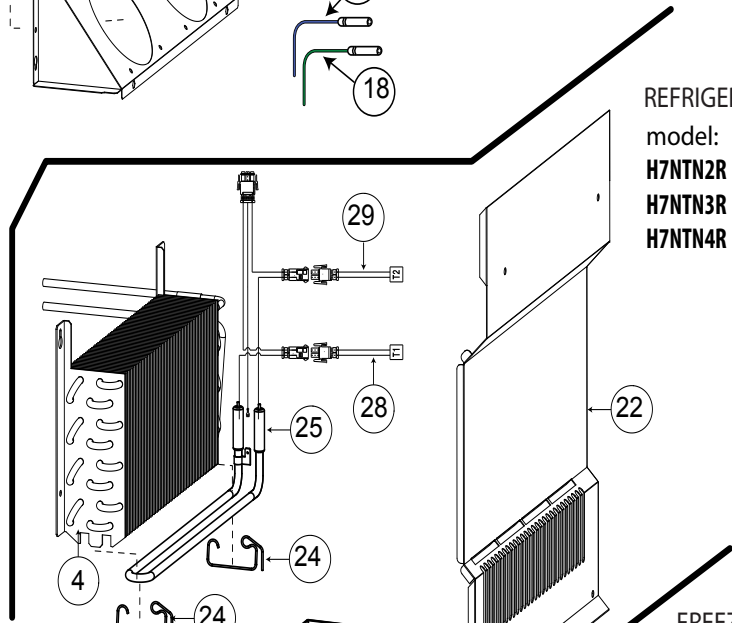

FREEZER HP & CL H700
model:
H7NBT2R
H7NBT3R

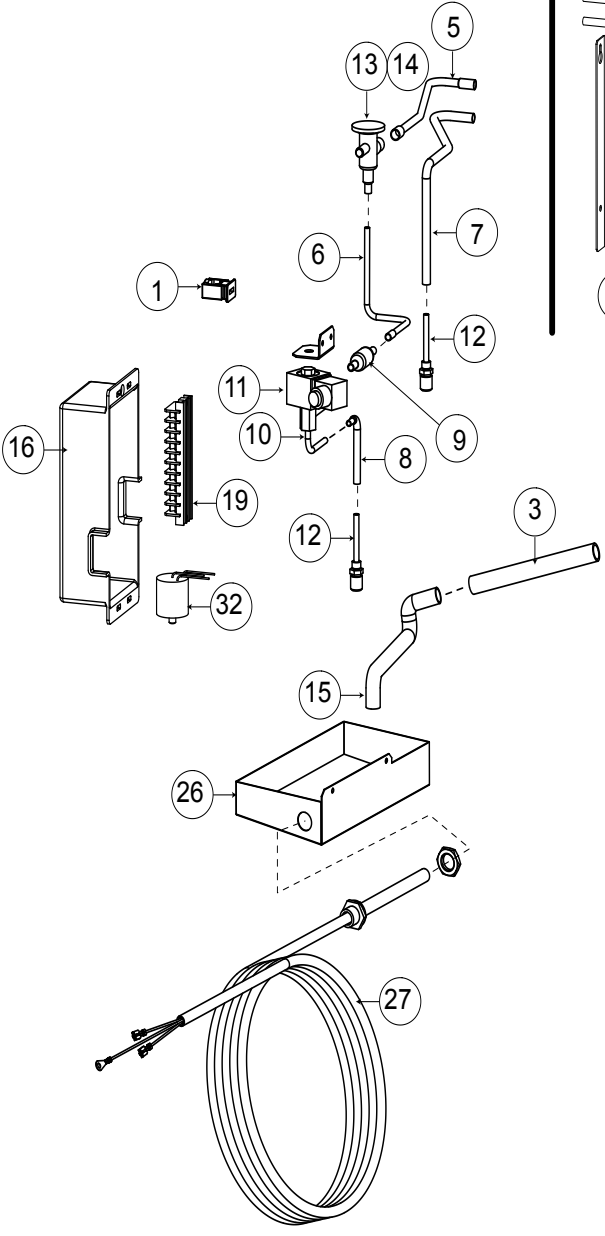
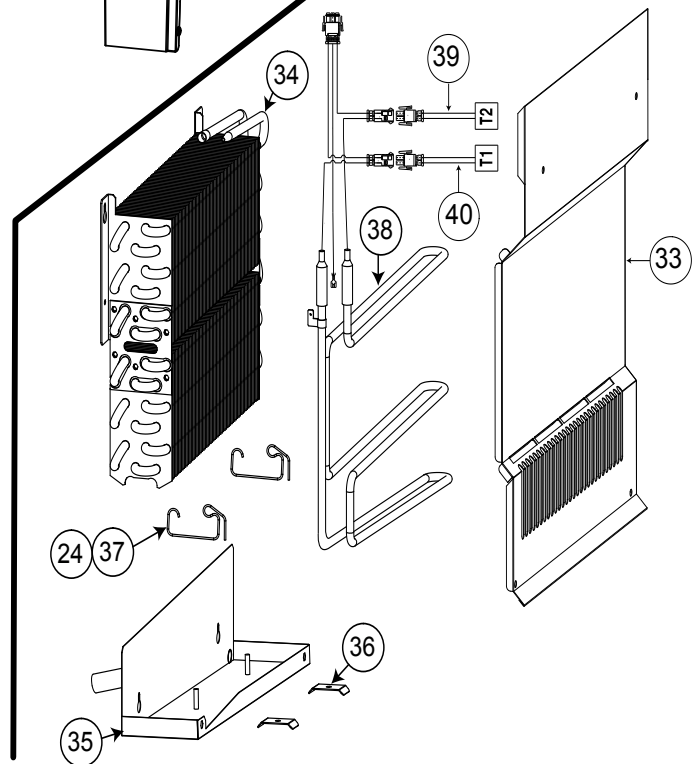

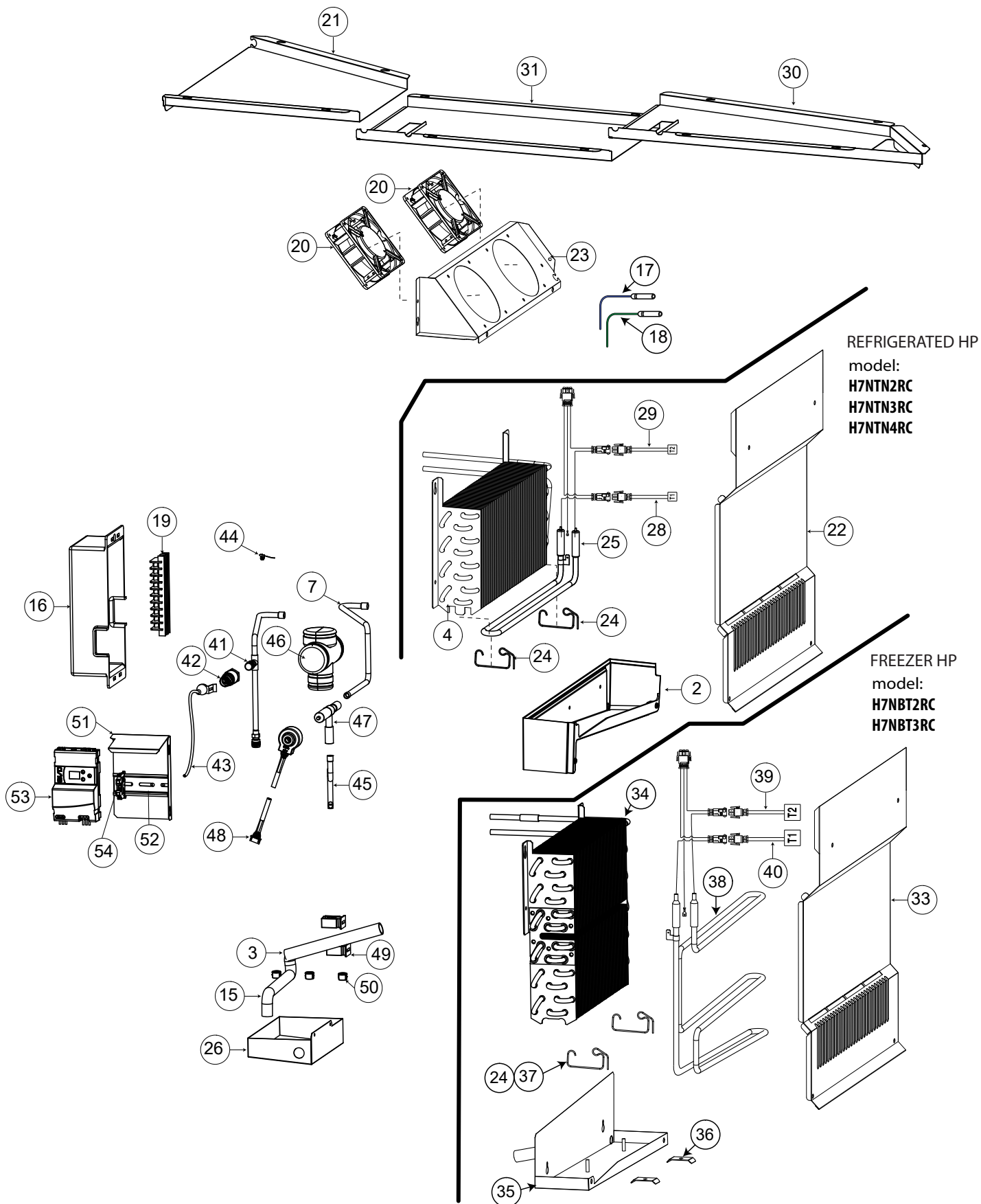

Pos	Code	Factory code	Description	Descrizione	Ref/notes
Reference pag.11-12					
Cooling unit 2-3-4 comp. refrigerated /freezer			Gruppo 2-3-4 vani refrigerato e freezer		
1	095996	639719400	STOPPER	CAVAL.CARPANETO 605/25	
2	095288	546R39801	WATER COLLECTOR BASIN refrigerated	BACINELLA	a,b,c,f,g,h
3		544R06400	DISCHARGE PIPE	TUBO SCARICO ACQUA BACIN. EXT	
4	095448	830R13900	EVAPORATOR TN	EVAPORATORE REMOTE H700 TN	a,b,c,f,g,h
5		515R34400	PIPE FROM THERM. VALVE TO EVAP. TN	TUBO DA TERMOS. A EVAPORATORE TN	a,b,c
5		515R35000	PIPE FROM THERM. VALVE TO EVAP. BT	TUBO DA TERMOS. A EVAPORATORE BT	d,e
6		515R34500	PIPE FROM THERM. VALVE TO SOLEN.	TUBO DA TERM. A VALVOLA SOLENOIDE	a,b,c,d,e
7		515R34600	EVAPORATOR FLOW BACK PIPE	TUBO DI ASPIRAZIONE	a,b,c,d,e
7		515R47100	EVAPORATOR FLOW BACK PIPE	TUBO DI ASPIRAZIONE	f,g,h,i,l
8		515R20000	INLET PIPE SOLENOID VALVE	TUBO INGRESSO VALVOLA SOLENOIDE	a,b,c,d,e
9	090229	525719000	FILTER	FILTRO MECCANICO A RETINA D6.2 D6.2	a,b,c,d,e
10	087694	646735000	BODY SOLENOID VALVE	CORPO VALV. SOLENOIDE	a,b,c,d,e
11	085847	0646729100	COIL WITHOUT CONNECTION	BOBINA PARKER	a,b,c,d,e Up to 2020/26
11	095063	0646R14000	COIL WITHOUT CONNECTION	BOBINA PARKER	a,b,c,d,e From 2020/27
12	0A8171	A02021800	SCHRADEN 4.00.10/2 RECHARG.VALVE	VALVOLA DI RICARICA	a,b,c,d,e
13	087333	646740901	THERMOSTATIC VALVE refrigerato R134a	VALVOLA TUB,RANGE N, -40/+10,OR.1 TN	a,b,c gas R134A HP only
13	088501	646751900	THERMOSTATIC VALVE refrigerato R404a	VALVOLA TUB,RANGE N, -40/+10,OR.1 TN	a,b,c gas R404A,R452A,R407F, R422A HP only
13	095674	646R16000	THERMOSTATIC VALVE refrigerato R448a	VALVOLA TUB,RANGE N, -40/+10,OR.1 TN	a,b,c gas R448A,R449A,R407C, R407A HP only
13	087334	646741000	THERMOSTATIC VALVE freezer HP & CL	VALVOLA TUB,RANGE N, -40/+10,OR.3 BT	d,e gas R404a/R452a
13	095541	646R13900	THERMOSTATIC VALVE freezer HP & CL	VALVOLA TUB,RANGE N, -40/+10,OR.3 BT	d,e R407C,R448A,R449A
13		652F00000	THERMOSTATIC VALVE freezer HP & CL	VALVOLA TUB,RANGE N, -40/+10,OR.3 BT	d,e R407A
14	089614	565717600	INSULATION THERMOSTATIC VALVE	ISOLANTE X VALVOLA TERMOST.	a,b,c,d,e
15	095458	544R07300	DISCHARGE WATER PIPE	SIFONE SCARICO ACQUA SX REMOTI	
16		549727400	BOX ELECTRICAL PROTECTION	SCATOLA PROTEZIONE IMP. ELETTRICO	
17	092175	646R06900	PROBE CELL	SONDA 6X20 BLU 'CELL' L=3000	
18	096125	646R07701	PROBE EVAPORATOR	SONDA 6X40 VERDE 'DEF' L=3000	
19		856R28800	WIRING/TERMINAL BOARD ASSEMBLY	MORSETTIERA CON CABLAGGIO	
20	095315	682R10700	FAN 120X120X38 MM IP55	VENTILATORI	
21		503R38200	COMMON PART AIR CONVEYOR TN	CONVOGLIATORE ARIA TN	a,b,c,f,g,h
21		503R38900	COMMON PART AIR CONVEYOR BT	CONVOGLIATORE ARIA BT	d,e,i,l
22	095294	503R01302	EVAPORATOR COVER	COPERTURA EVAPORATORE TAV. TN	a,b,c,f,g,h
23	095359	503R01203	FANS SUPPORT EVAPORATOR	SUPPORTO VENTILATORI	
24	095279	514R24201	SPRING FOR ARMORED HEATING	MOLLA FIX. RESISTENZA TAV NGC TN	
25	095434	856R28600	ARMORED HEATING ASS	RESISTENZA EVAPORATORE	
26	091356	512701800	EVAPORATION BASIN	BACINELLA DI EVAP. CONDENSA	
27	083814	617R03800	PTC EXTERNAL	PTC	
28	095431	856R29400	ARMORED HEATING THERMOST.T1 +20°	TERMOST. DI SICUREZZA RESIST. T1 +20°	a,b,c,f,g,h
29	095431	856R29400	ARMORED HEATING THERMOST.T2 +20°	TERMOST. DI SICUREZZA RESIST. T2 +20°	a,b,c,f,g,h
30		503R38400	END PART AIR CONVEYOR TN	PARTE FINALE CONVOGLIATORE ARIA	b,c,eg,h,i,l with draw. and doors
31		503R38300	MID PART AIR CONVEYOR	PARTE CENTRALE PER CONV. ARIA	c,h
32	096636	694R00502	RFI FILTER	FILTRO ANTIDISTURBO	d,e
33	095318	503R28501	EVAPORATOR COVER	COPERTURA EVAPORATORE TAV. BT	d,e,i,l
34	095449	830R14000	EVAPORATOR BT	EVAPORATORE REMOTE H700 BT	d,e
34		830R02H00	EVAPORATOR TN CO2 REMOTE	EVAPORATORE REMOTE H700 TN CO2	f,g,h
34		830R02J00	EVAPORATOR BT CO2 REMOTE	EVAPORATORE REMOTE H700 BT CO2	i,l
35	095362	502R93301	WATER COLLECTOR BASIN freezer	BACINELLA PER CONGELATORE ONLY	d,e,i,l

Pos	Code	Factory code	Description	Descrizione	Ref/notes
36	095282	503R29200	ARMORED HEATER FIXING BRACKET	STAFFA PER RESISTENZA CORAZZATA	d,e,i,l
37	095283	503R29400	ALLUMINIUM TIE	FASCIETTA IN ALLUMINIO	d,e
38	095435	856R28700	ARMORED HEATING ASS	RESISTENZA CON TEMOSTATI	d,e,i,l
39	095432	856R29500	ARMORED HEATING THERMOST.T1 +8°	TERMOST. DI SICUREZZA RESIST. T1 +8°	d,e,i,l
40	095432	856R29500	ARMORED HEATING THERMOST.T2 +8°	TERMOST. DI SICUREZZA RESIST. T2 +8°	d,e,i,l
41		515R47000	EVAPORATOR OUTLET PIPE WITH PRES-SURE PROBE	TUBO USCITA EVAPORATORE CON SONDA DI PRESSIONE	f,g,h,i,l
42	097031	646R06K01	PRESSURE SENSOR 90 BAR	SENSORE DI PRESSIONE 90 BAR	f,g,h,i,l
43	097027	634R01S01	CABLE AWG 3 WIRES L=2M FOR PRES-SURE SENSOR	CAVO AWG 3 L=2M PER SENSORE DI PRESSIONE	f,g,h,i,l
44	097032	646R06L01	SENSOR NTC HF L=1.80MT	SONDA NTC HF L=1.80MT	f,g,h,i,l
45		515R47200	THERMOSTATIC VALVE INLET PIPE	TUBO INGRESSO VALVOLA TERMOSTATICA	f,g,h,i,l
46	089614	565717600	VALVE PROTECTION	GUSCIO COIBENTATO	f,g,h,i,l
47	097030	646R06C01	THERMOSTATIC VALVE	VALVOLA TERMOSTATICA	f,g,h,i,l
48	097034	805R00L01	UNIPOLAR STATOR	STATORE UNIPOLARE DA 1M PER E2V%U	f,g,h,i,l
49	094127	639700500	WIRING STOPPER	FERMACAVO CARPANETO 3040/LGK 6/16 MM. CABLE FASTEN	f,g,h,i,l
50	0TH222	639705500	CABLE GLAND	B70 PASSACAVO HEYCO SB500/6FORO 12,7 CABLE CLAMP	f,g,h,i,l
51		504R26500	DRIVER SUPPORT	SUPPORTO PER DRIVER	f,g,h,i,l
52	097006	639812201	DIN BAR	BARRA DIN L=90 MM	f,g,h,i,l
53	097033	648R02A01	DRIVER EVD MINI 115/230V WITH DISPLAY	DRIVER EVD MINI 115/230V CON DISPLAY	f,g,h,i,l
54	094825	0639726500	CLAMP	MORSETTO	f,g,h,i,l

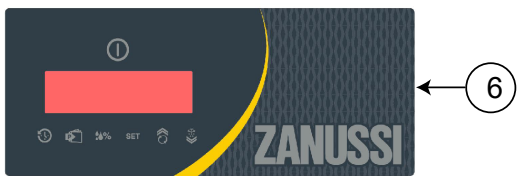
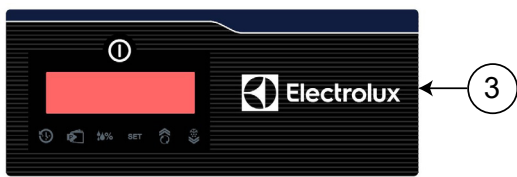
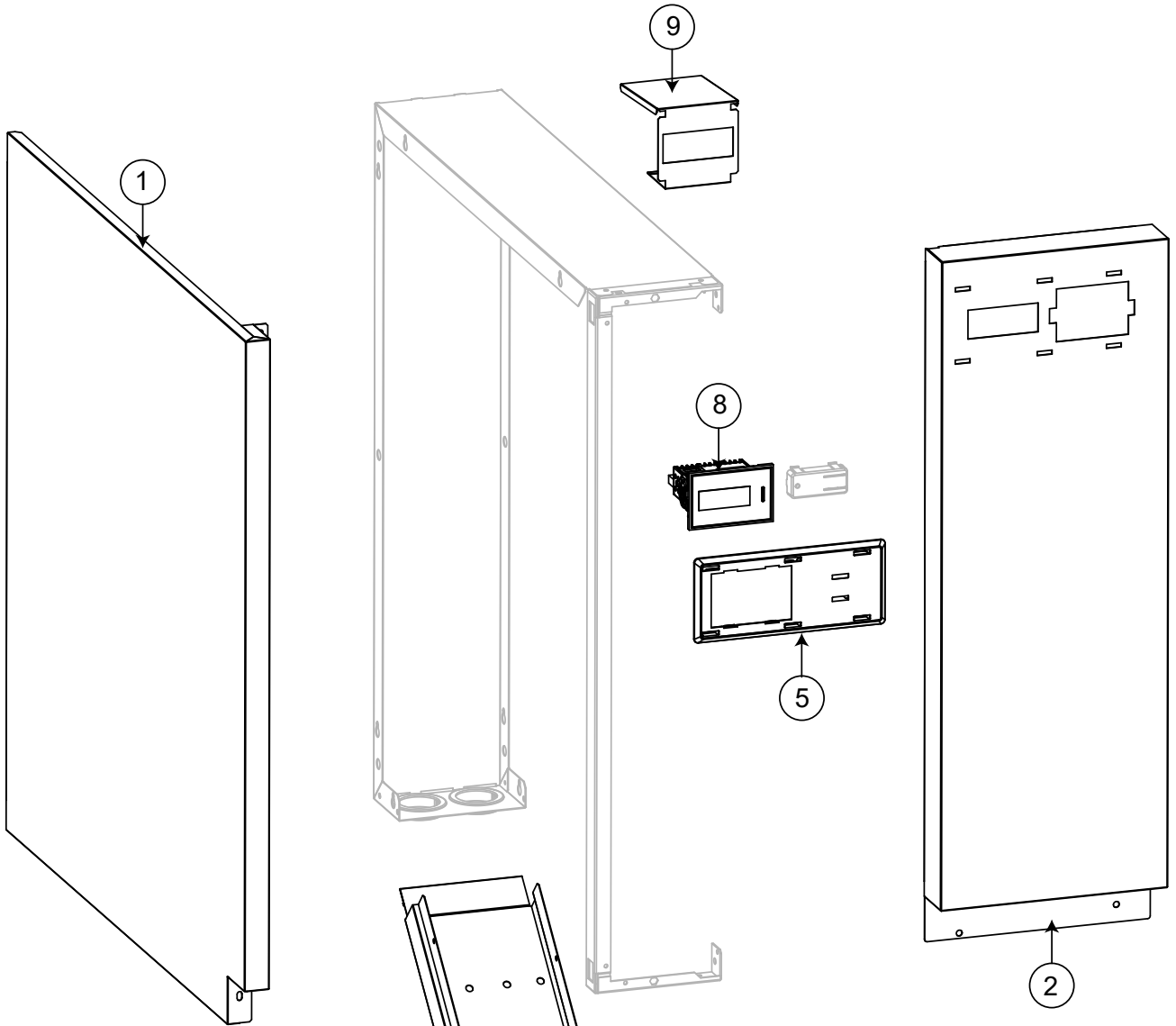

Range only HP
 MODEL=H7NTN2R
 H7NTN3R
 H7NTN4R
 H7NBT2R
 H7NBT3R
 H7NTN2RC
 H7NTN3RC
 H7NTN4RC
 H7NBT2RC
 H7NBT3RC

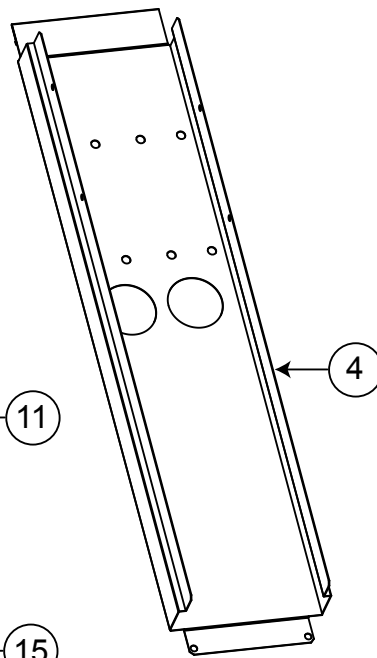
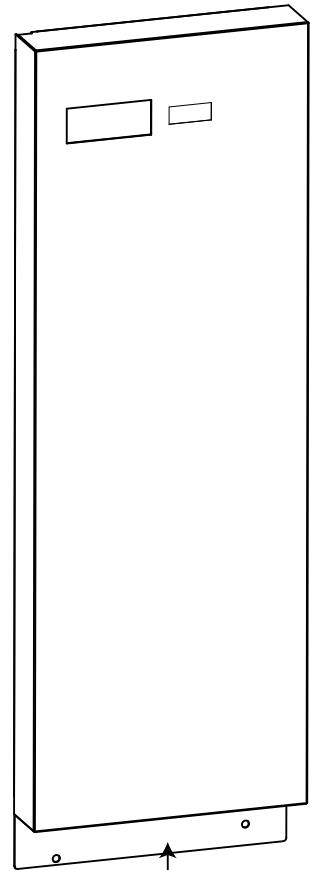
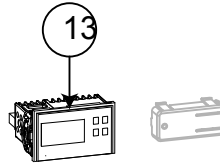
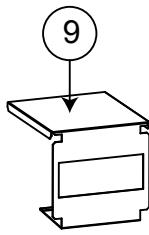
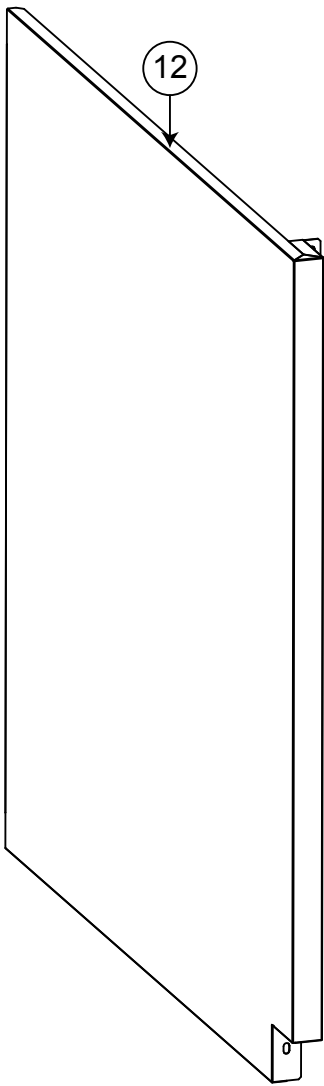

Range only CL
MODEL=H7NBT2R
H7NBT3R

Pos	Code	Factory code	Description	Descrizione	Ref/notes
Reference pag.15-16					
Control panel			Pannello di controllo		
1	095247	502R85102	EXTERNAL SIDE PANEL H700 HP	PANNELLO ESTERNO	a,b,c,d,e,f,g,h,i,l
2		509R21100	CONTROL PANEL	PANNELLO DI CONTROLLO	
3	095436	755R11802	STICKER CTRL EPR REFRIGER.	MEMBRANA CON TASTI EPR TN	a,b,c,f,g,h (EPR) only HP
3	095442	755R12402	STICKER CTRL EPR FREEZER	MEMBRANA CON TASTI EPR BT	d,e,f,i,l (EPR) only HP
4		503R56300	TRAY SUPPORT GALVANIZE	SUPPORTO BACINELLA IN ZINCATO	
4		503R58702	TRAY SUPPORT AISI 304	SUPPORTO BACINELLA IN A304	
5		546R40900	FRAME DIGITAL CTRL REM. MOD.	CORNICE PER CONTROLLORE	
6	095437	755R11900	STICKER CONTROL ZAN REFRIGER.	MEMBRANA CON TASTI ZAN TN	a,b,c,f,g,h (ZANUSSI)
6	095443	755R12501	STICKER CONTROL ZAN FREEZER	MEMBRANA CON TASTI ZAN BT	d,e,i,l (ZANUSSI)
7	095438	755R12001	STICKER CONTROL APX REFRIGER. HP	MEMBRANA CON TASTI APX TN HP	a,b,c,f,g,h (APX)
7	095444	755R12601	STICKER CONTROL APX FREEZER HP	MEMBRANA CON TASTI APX BT HP	d,e,i,l (APX)
8	093437	646R10602	CONTROLLER IUUEL101404 IR33	TERMOR. CAREL IUUEL101404 IR33	
9		503R49700	REMOTE COVER	COPERTURA CONTROLLORE REMOTA	
10		503R35900	CONTROL PANEL CL freezer	PANNELLO DI CONTROLLO CL freezer	d,e only CL freezer
11		755R15200	STICKER CTRL EPR FREEZER CL	MEMBRANA CON TASTI EPR BT	d,e (EPR) only CL
12	095631	503R62601	EXTERNAL SIDE PANEL H700 CL	PANNELLO ESTERNO	d,e only CL freezer
13	093434	646R11101	TERMOREGOLAT. IR33 IMEL1J0559	CONTROLLORE IR33	d,e only CL freezer - Up to 2023/16 order KIT 097750, see TB VTX2023_08
13	097579	855R18401	TERMOREGOLAT. IJF SMALL	CONTROLLORE IJF SMALL	d,e only CL freezer - From 2023/17
14	095618	755R15100	STICKER CONTROL APX FREEZER CL	MEMBRANA CON TASTI APX BT CL	d,e only CL freezer
15		755R15300	STICKER CONTROL ZAN FREEZER CL	MEMBRANA CON TASTI ZAN BT CL	d,e only CL freezer
16					
17					
18					
19					
20					
21					
22					
23					
24					

Finanzen / Service

28307 Bremen
Thalendorststraße 15
Tel.+49 421 48557-0
Fax+49 421 488650
bremen@nordcap.de

Vertrieb Ost

12681 Berlin
Wolfener Straße 32/34, Haus K
Tel.+49 30 936684-0
Fax+49 30 936684-44
berlin@nordcap.de

Vertrieb West

40699 Erkrath
Max-Planck-Straße 30
Tel.+49 211 540054-0
Fax+49 211 540054-54
erkrath@nordcap.de

Vertrieb Nord

21079 Hamburg
Großmoorbogen 5
Tel.+49 40 766183-0
Fax+49 40 770799
hamburg@nordcap.de

Vertrieb Süd

55218 Ingelheim
Hermann-Bopp-Straße 4
Tel.+49 6132 7101-0
Fax+49 6132 7101-20
ingelheim@nordcap.de



www.nordcap.de