

# Masszeichnung

## Backwarenkühltisch UBKE 1-46-1T MFL (R-290)

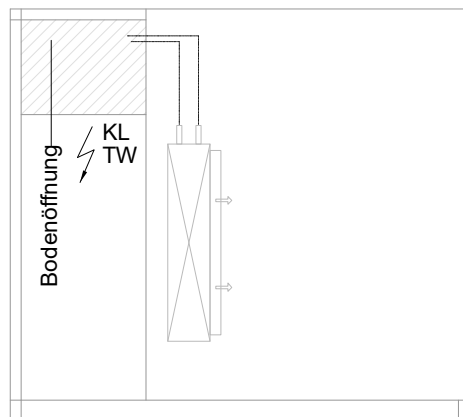
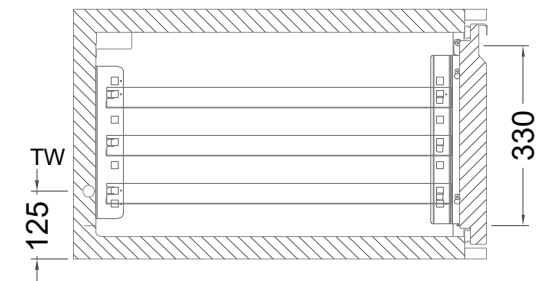
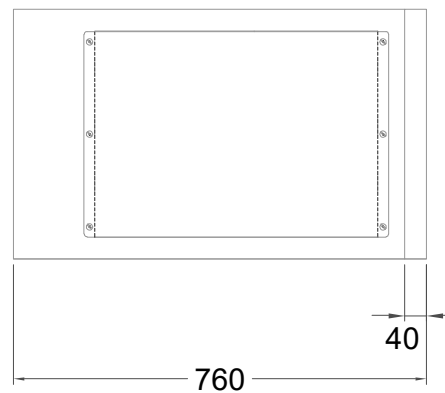
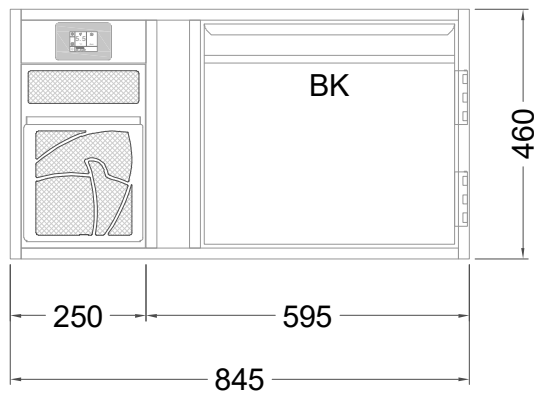

[Art.Nr.: 31000665]

**UBKE 1-46-1T**

- \* KL...Kälteleitungen
- \* TW...Tauwasser - in der Rückwand geführt, selbstständige Verdunstung über Aggregatabwärme, kein bauseitiger Ablauf erforderlich
- \* ⚡ Elektroanschluss