

# Masszeichnung

## Backwarenkühltisch UBKZ 3-51-3T IFR (zeltralgekuehrt)

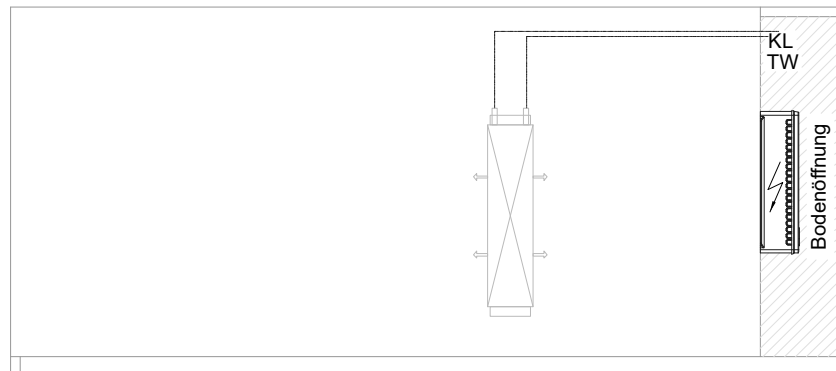
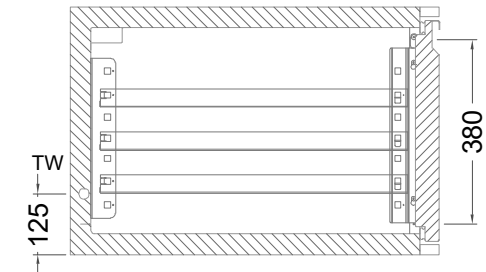
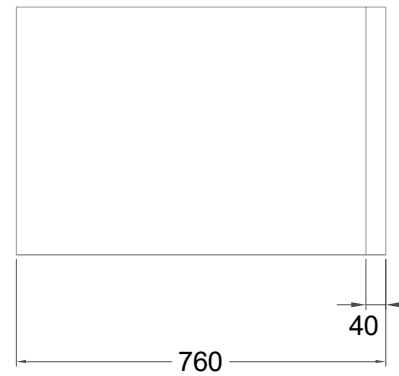

[Art.Nr.: 31000750]

**UBKZ 3-51-3T**

- \* KL...Kälteleitungen
- \* TW...Tauwasser - bauseitiger Siphon und Ablauf erforderlich
- \* ⚡ Elektroanschluss