

Masszeichnung

Backwarenkühltisch UBKZ 4-56-4T IFL (zentralgekuehlt)

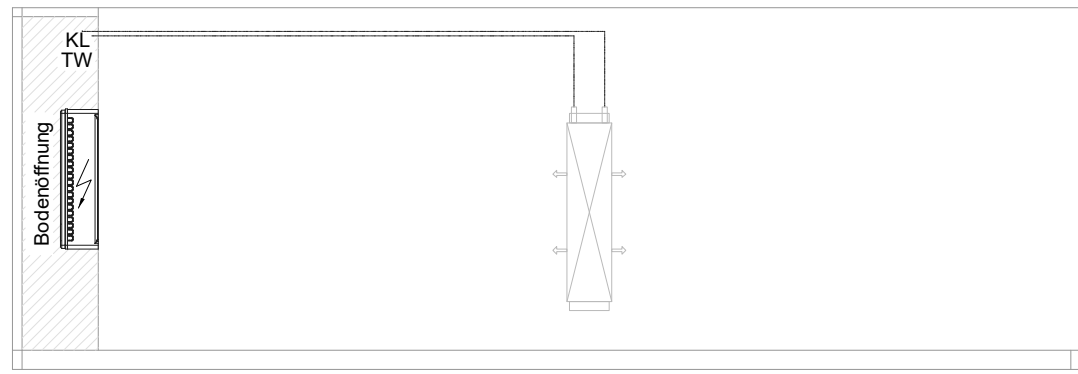
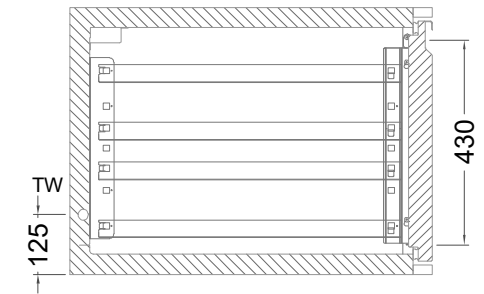
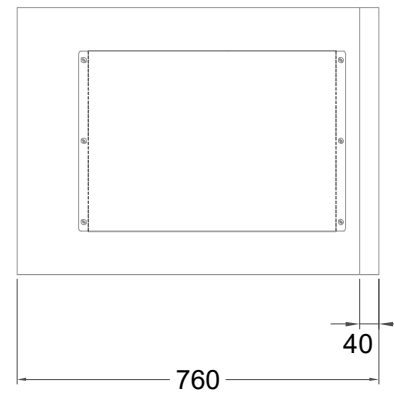

[Art.Nr.: 31000767]

UBKZ 4-56-4T

- * KL...Kälteleitungen
- * TW...Tauwasser - bauseitiger Siphon und Ablauf erforderlich
- * ⚡ Elektroanschluss