

Masszeichnung

Backwarenkühltisch BKZ 4-65-4T IFL (zentralgekuehlt)

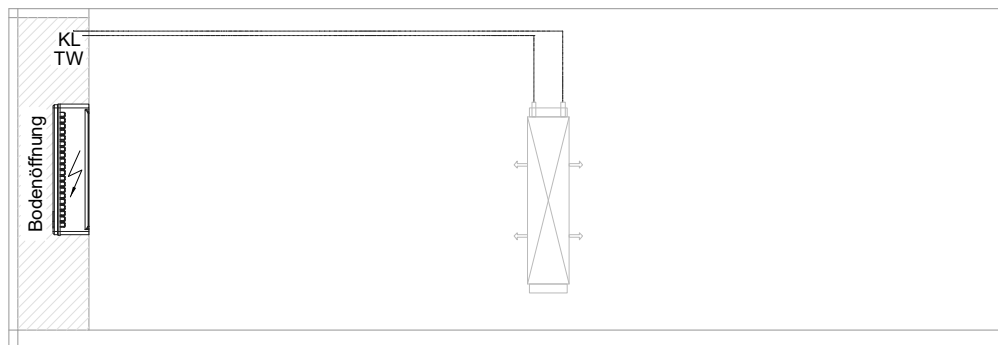
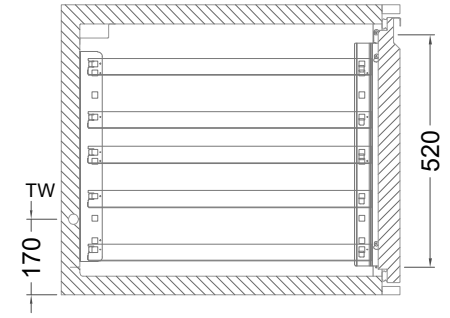
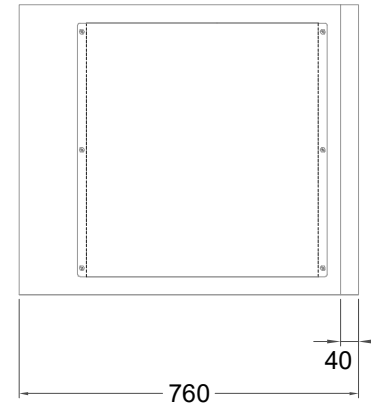
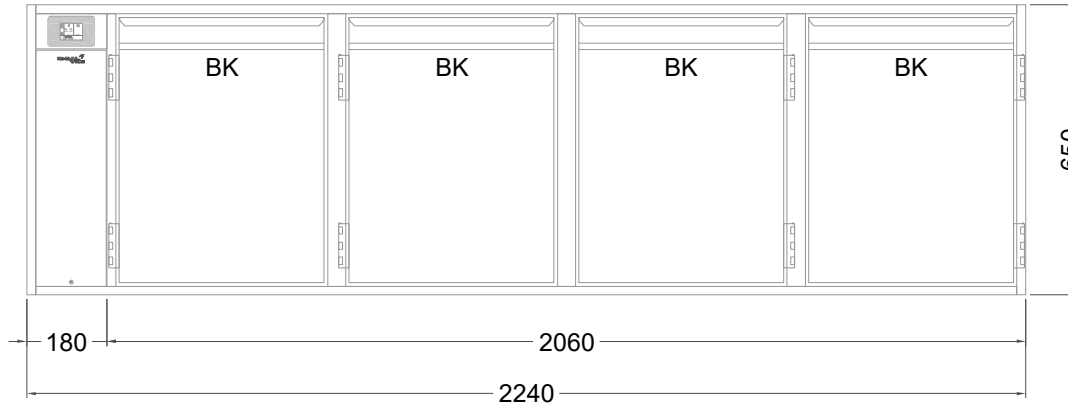

[Art.Nr.: 31000769]

BKZ 4-65-4T

- * KL...Kälteleitungen
- * TW...Tauwasser - bauseitiger Siphon und Ablauf erforderlich
- * ⚡ Elektroanschluss