

Masszeichnung

Backwarenkühltisch BKZ 1-65-1T IFL (zentralgekuehlt)

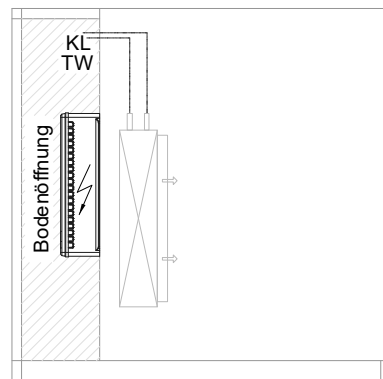
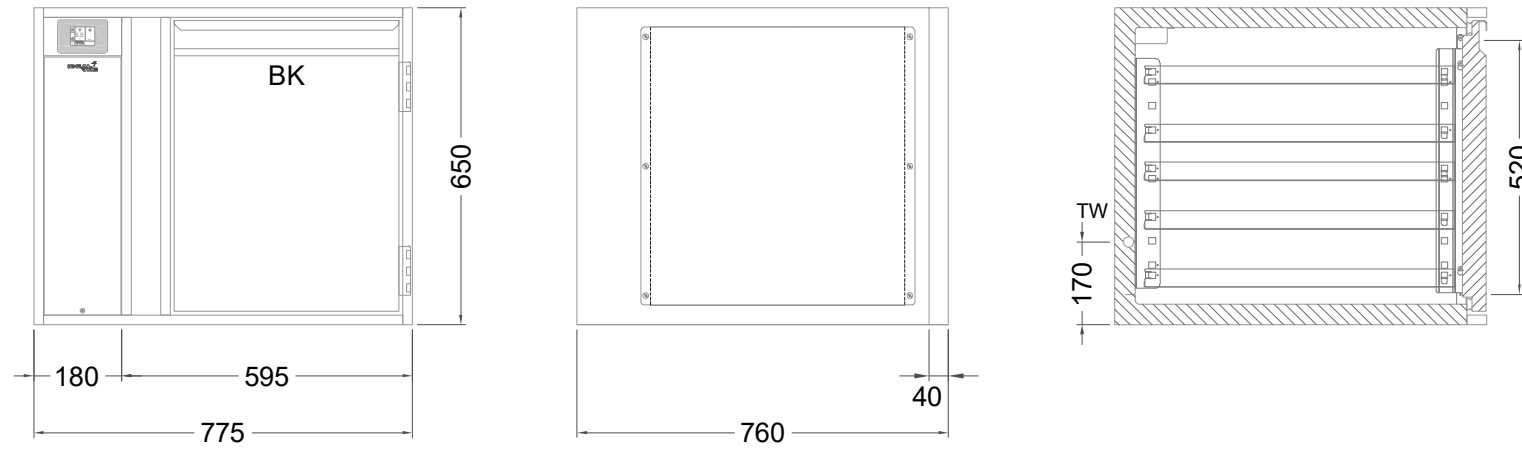

[Art.Nr.: 31000727]

BKZ 1-65-1T

- * KL...Kälteleitungen
- * TW...Tauwasser - bauseitiger Siphon und Ablauf erforderlich
- * ⚡ Elektroanschluss