

Masszeichnung

Backwarenkühltisch UBKZ 1-56-1T IFL (zentralgekuehlt)

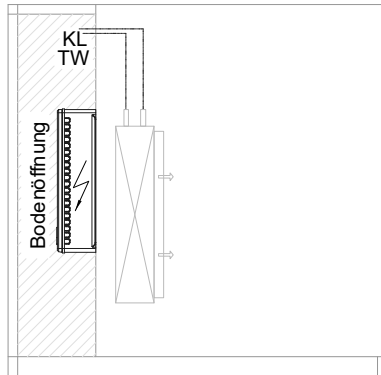
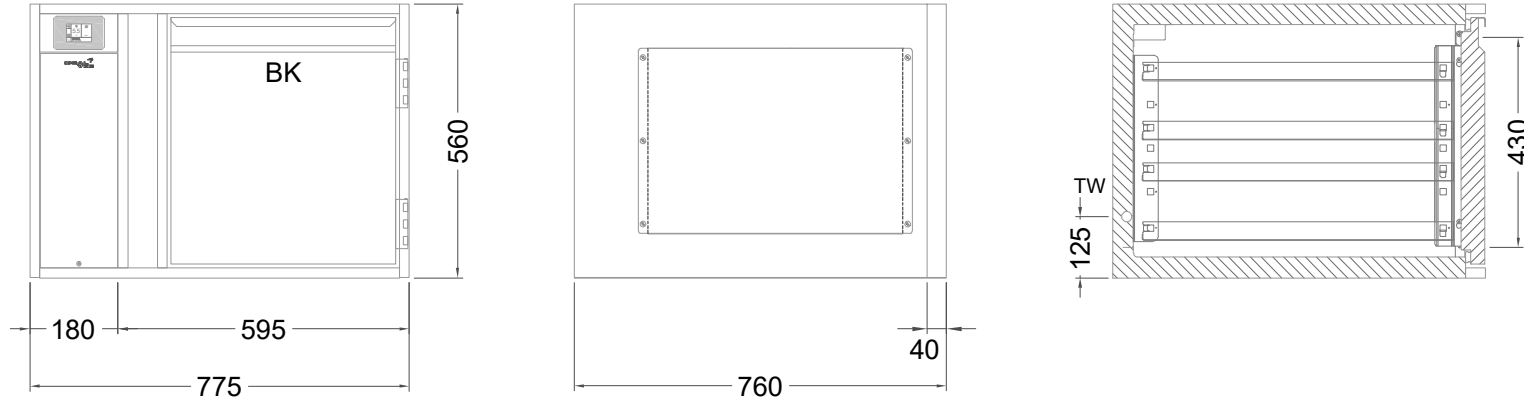

[Art.Nr.: 3100725]

UBKZ 1-56-1T

- * KL...Kälteleitungen
- * TW...Tauwasser - bauseitiger Siphon und Ablauf erforderlich
- * ⚡ Elektroanschluss