

# Masszeichnung

## COOL-LINE-Freikühltheke PATAGONIA 200 UM BLACK

[Art. 506120200]

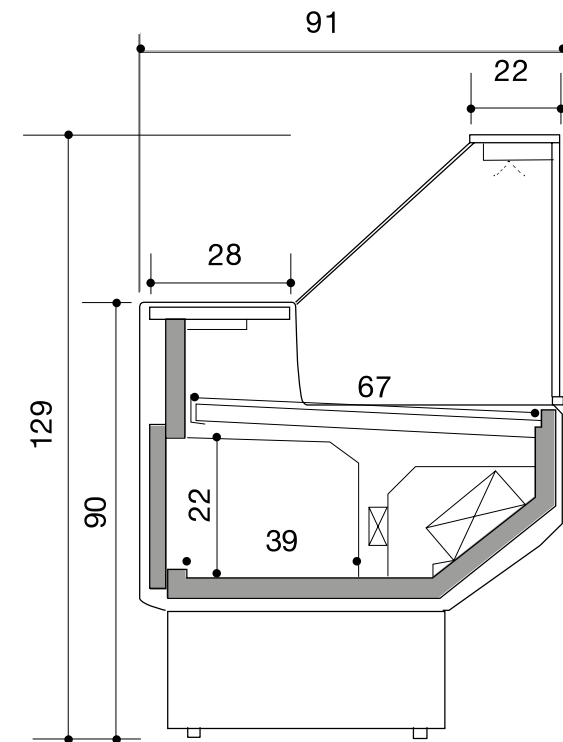
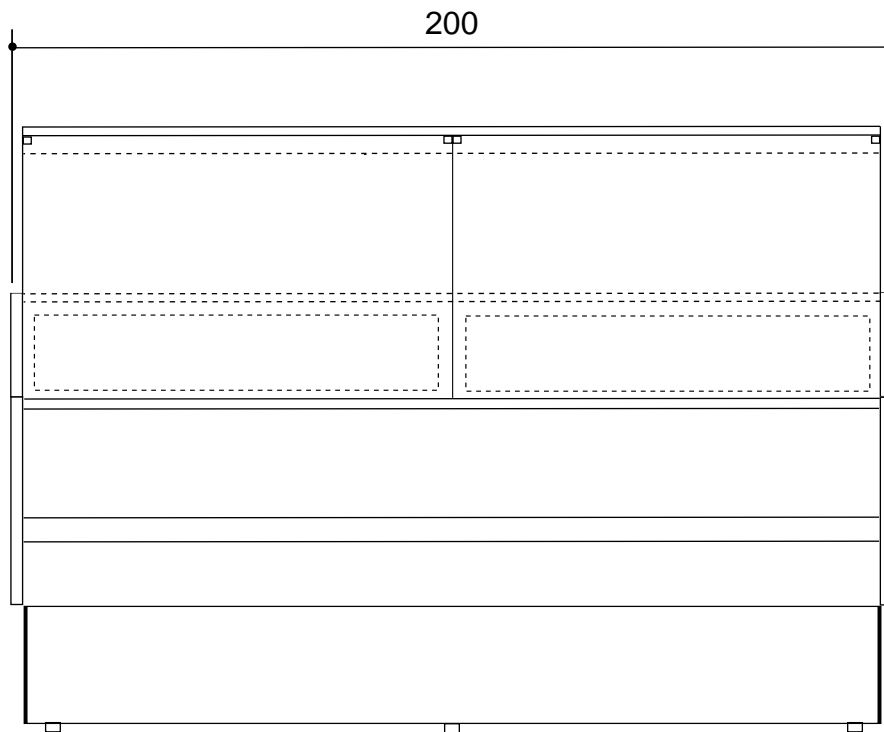

\* Alle Angaben in cm