

Schaltplan

Neutrales Kochtresen-Element **NTEC2-3P**

[Art. 406352081]

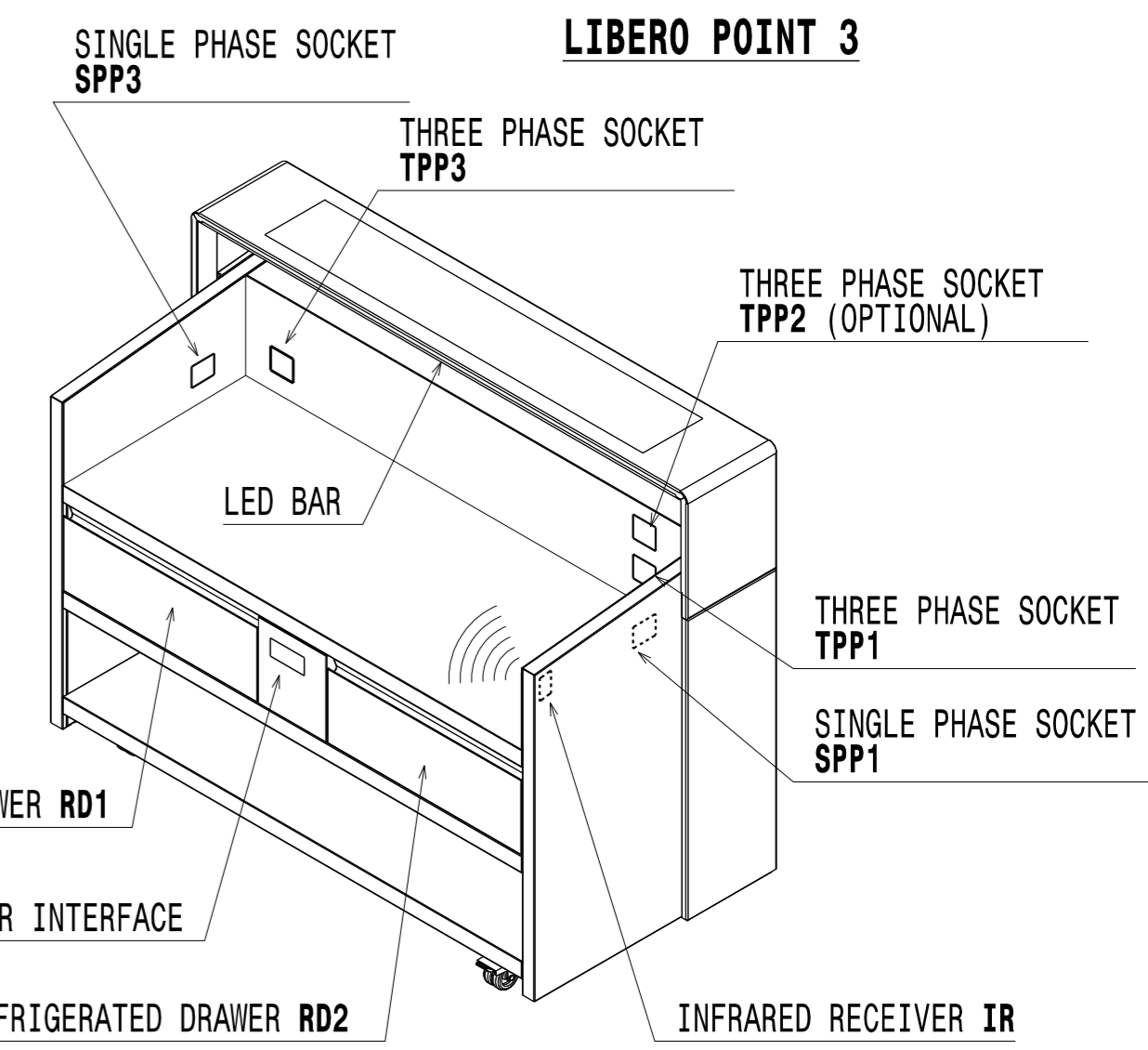

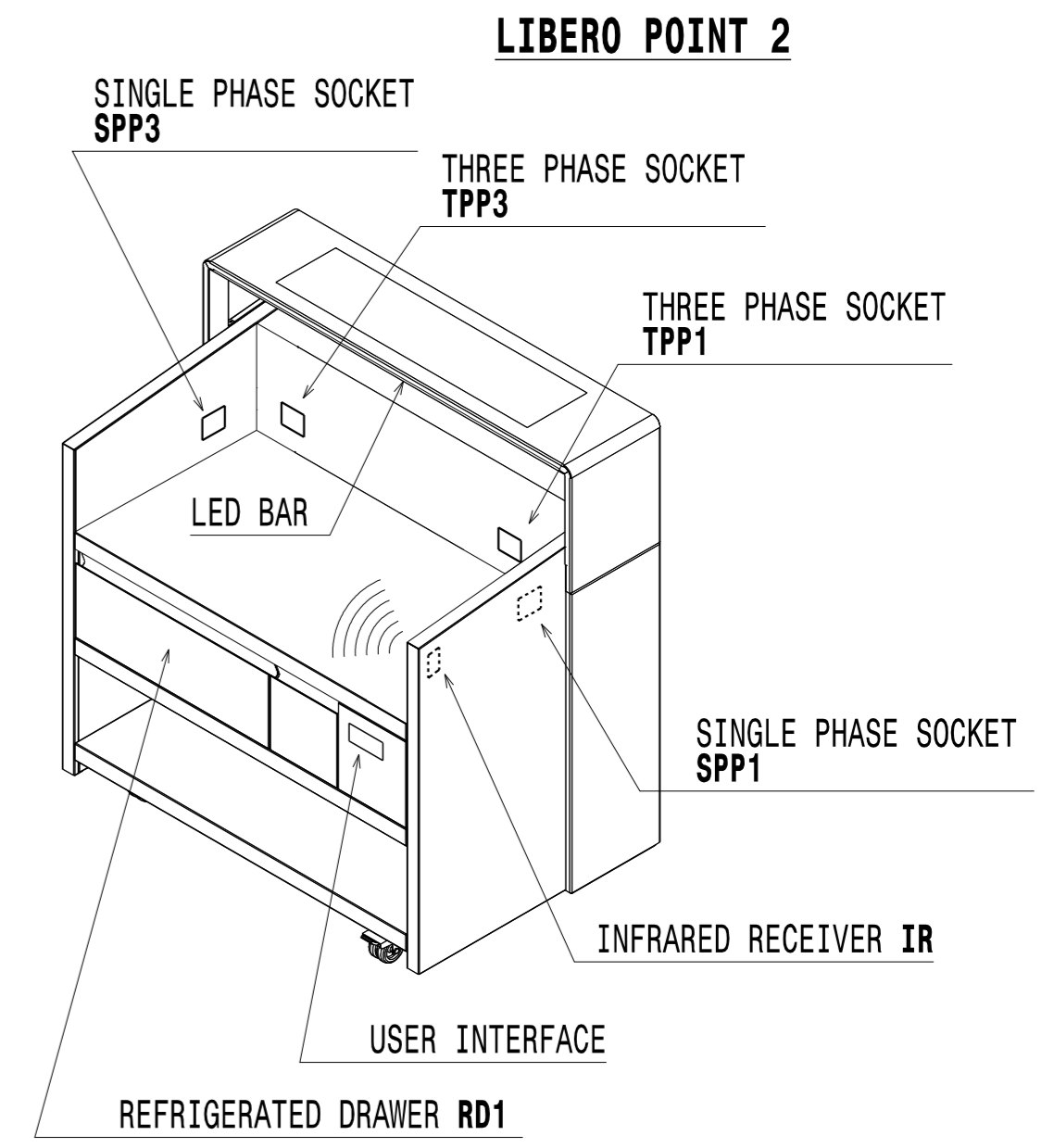
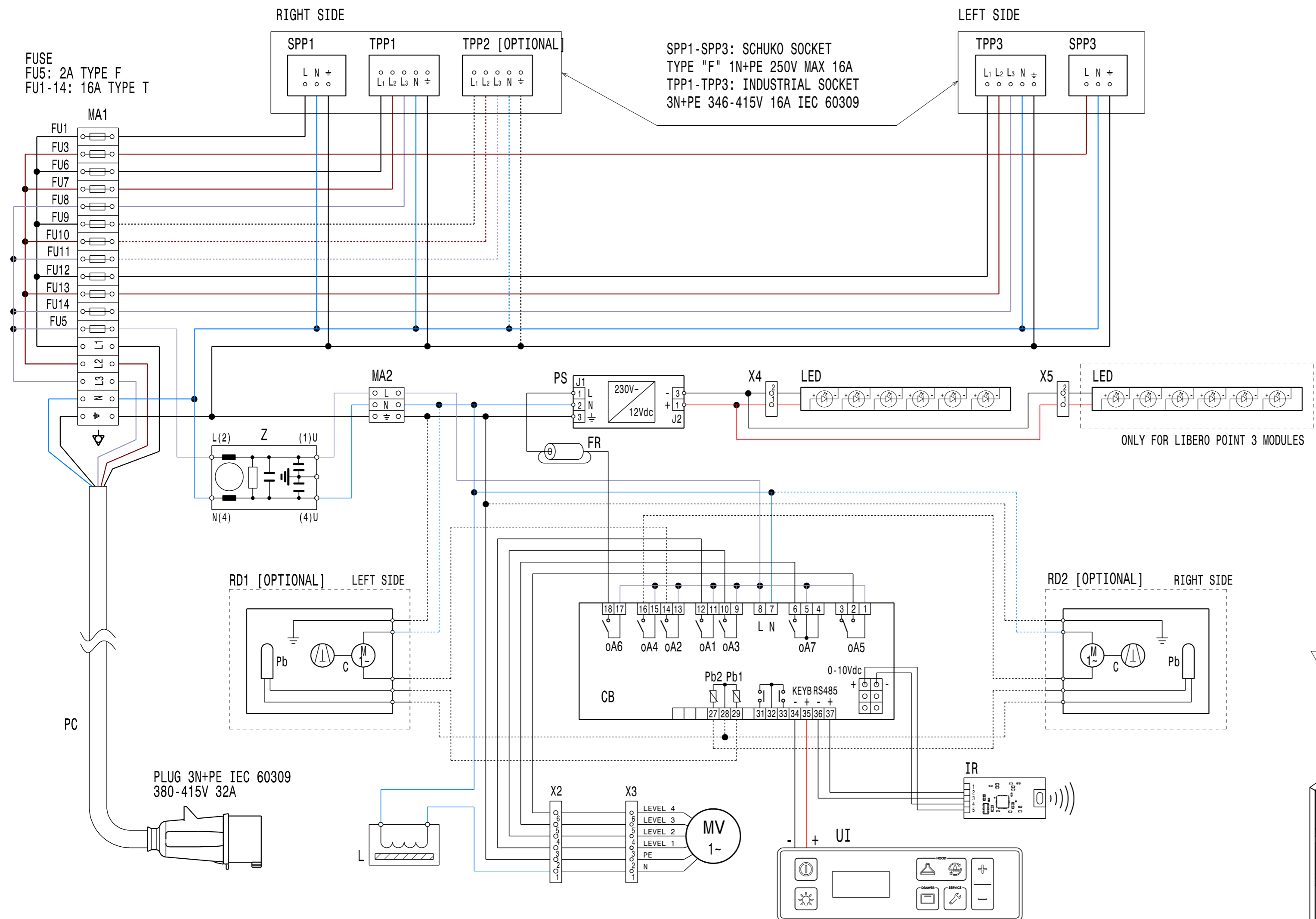

MA1-2	MORSETTIERA	TERMINAL BLOCK
RD1	CASSETTO REFRIGERATO SX	REFRIGERATED DRAWER SX
RD2	CASSETTO REFRIGERATO DX	REFRIGERATED DRAWER DX
MV	MOTOVENTILATORE	FAN MOTOR
UI	INTERFACCIA UTENTE	USER INTERFACE
CB	SCHEDA DI CONTROLLO	CONTROL BOARD
IR	RICEVITORE INFRAROSSI	INFRARED RECEIVER
X2-5	CONNETTORE	CONNECTOR
FU1-FU14	FUSIBILE	FUSE
TPP1-3	PRESA TRIFASE	THREE PHASE SOCKET
SPP1-3	PRESA MONOFASE	SINGLE PHASE SOCKET
LED	BARRA LED	LED STRIP
PS	ALIMENTATORE 12Vdc	POWER SUPPLY 12Vdc
PC	CAVO DI ALIMENTAZIONE	POWER CORD

MODELS WITHOUT REFRIGERATED DRAWERS:
 380-415V~ 3N 50/60Hz
 MAX POWER 300W (WITHOUT CONSIDER SOCKETS LOAD)
 MAX AMPACITY 32A

MODELS WITH REFRIGERATED DRAWERS:
 380-415V~ 3N 50Hz
 380-400V~ 3N 60Hz
 MAX POWER 400W (WITHOUT CONSIDER SOCKETS LOAD)
 MAX AMPACITY 32A

Z	FILTRO ANTIDISTURBO	SUPPRESSOR FILTER
FR	FERRITE	FERRITE
L	INDUTTANZA	INDUCTANCE

NordCap GmbH & Co. KG
Thalenhorststraße 15
28307 Bremen
Hauptsitz (Service, Finanzen & Personal, Lager, IT, Marketing)

Telefon: +49 421 48557-0
Telefax: +49 421 488650
E-Mail: bremen@nordcap.de

Die NordCap Verkaufsniederlassungen in Deutschland:

Nord: Hamburg • Ost: Berlin • Süd: Ingelheim • West: Erkrath

by **NordCap**[®]

ZANUSSI
PROFESSIONAL