

Masszeichnung

Backwarenkühltisch UBKE 4-46-4T MFL (R-290)

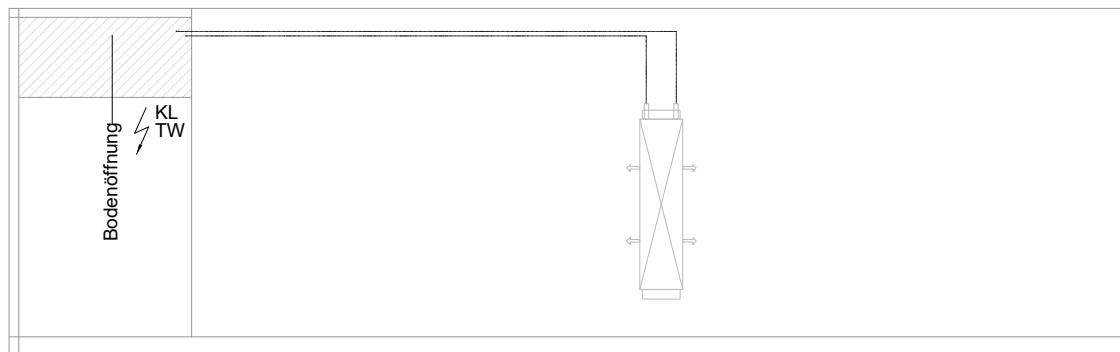
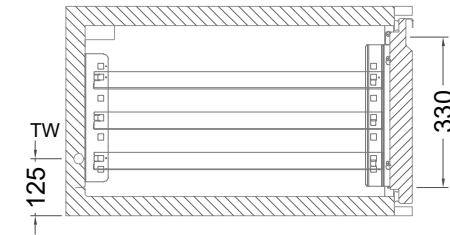
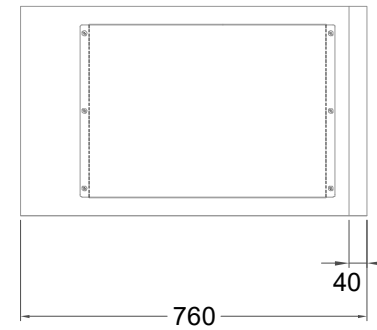
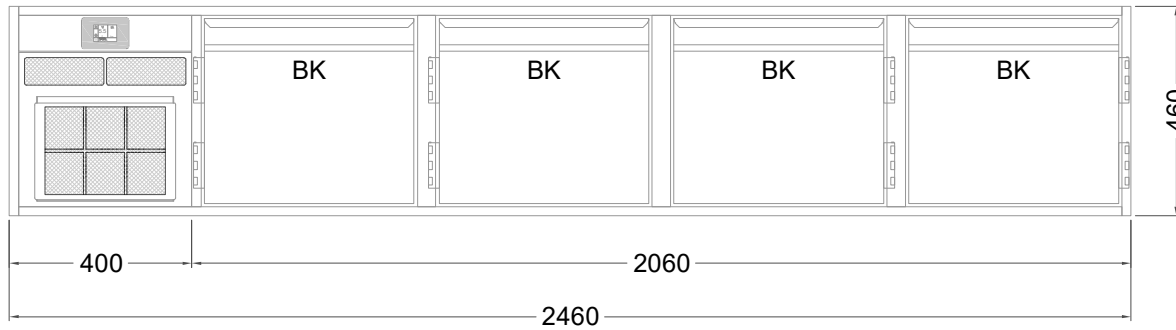

[Art.Nr.: 31000707]

UBKE 4-46-4T

- * KL...Kälteleitungen
- * TW...Tauwasser - in der Rückwand geführt, selbstständige Verdunstung über Aggregatabwärme, kein bauseitiger Ablauf erforderlich
- * ⚡ Elektroanschluss