

Masszeichnung

Einbaukühlvitrine BAK GE-92-53-E R290

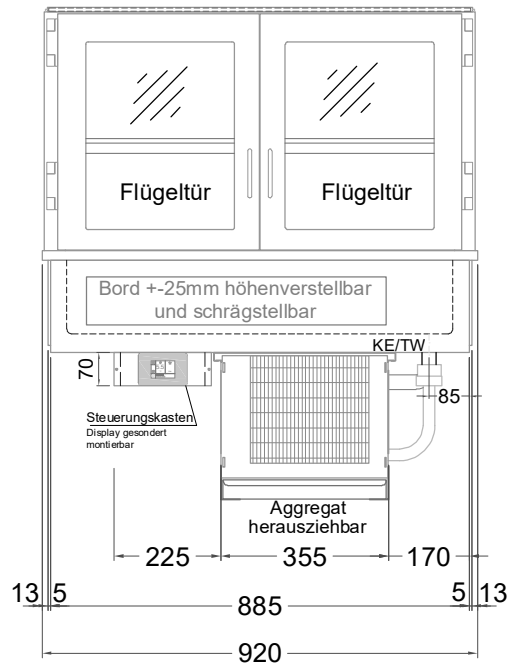

(Bedienseite)



(Seitenansicht)

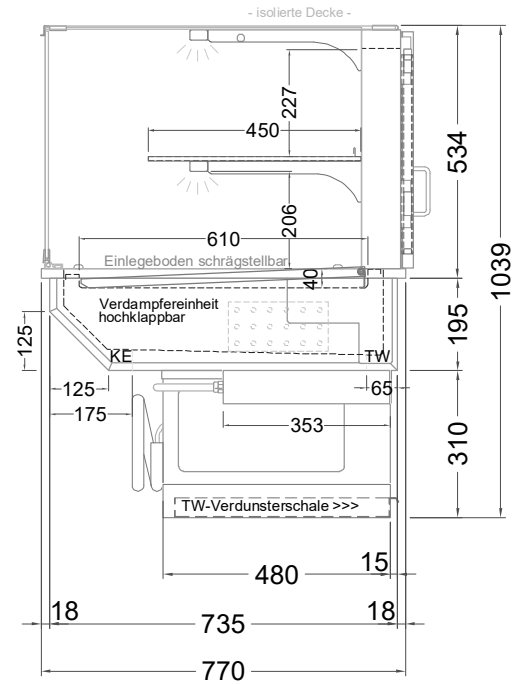

(Kundenseite)

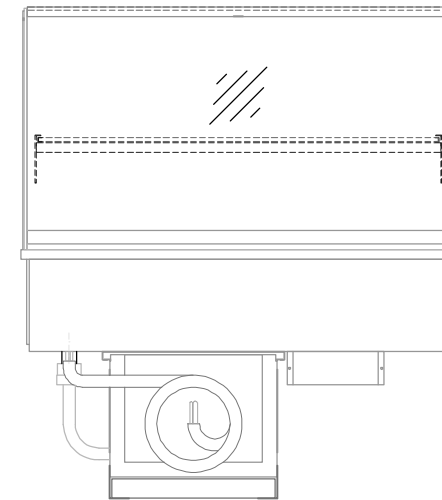

(Grundriss)

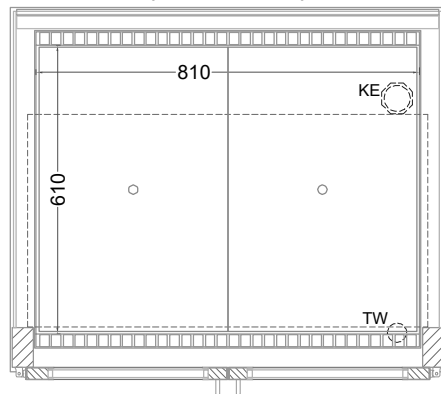

TW = Tauwasserablauf DNØ30
KE = Kälte-Elektro

[Art.Nr.: 357211]

BAK GE-92-53-E R290