

Masszeichnung

Kühltisch (4 Abteile) KTZ 4-76-4T IFR (zentralgekuehlt)

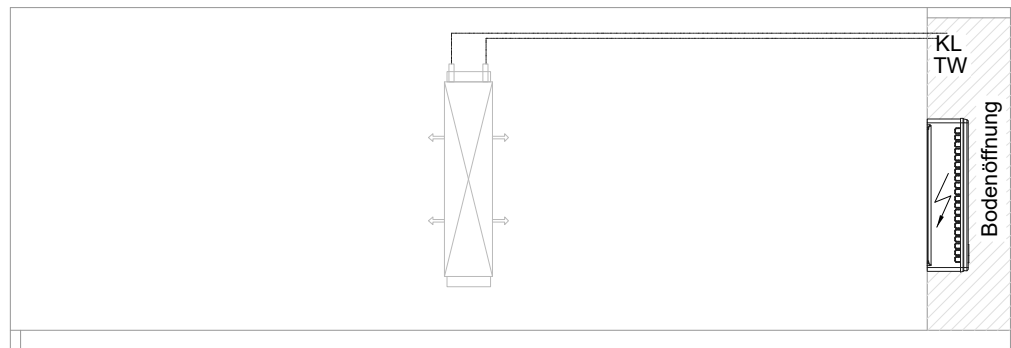
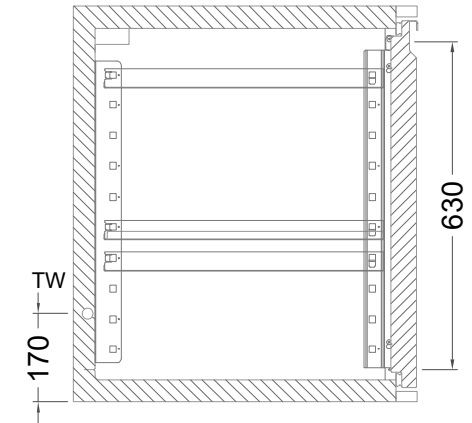
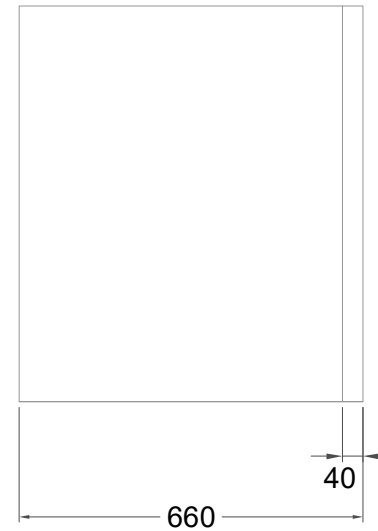
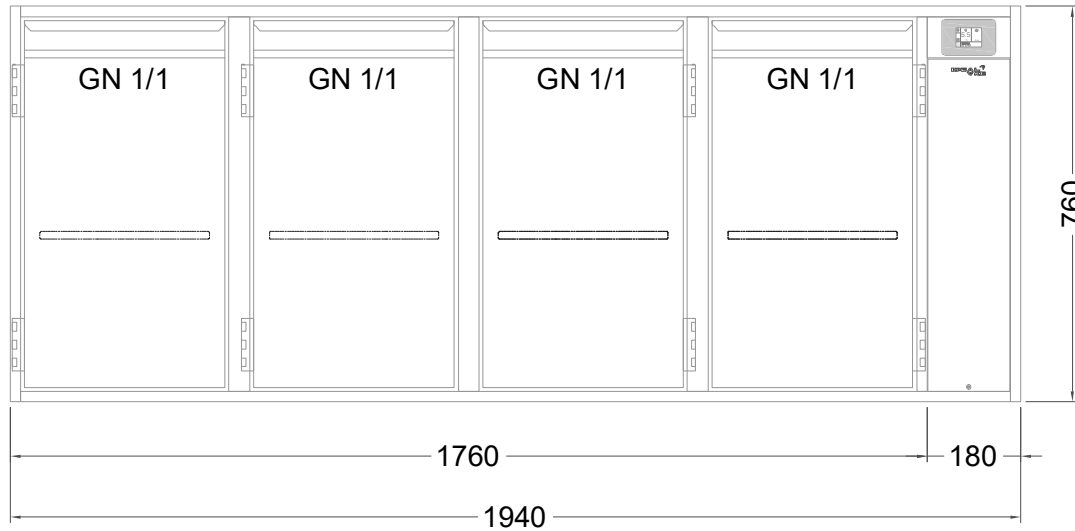

[Art.Nr.: 31000662]

KTZ 4-76-4T

- * KL...Kälteleitungen
- * TW...Tauwasser - bauseitiger Siphon und Ablauf erforderlich
- * ⚡ Verdrahtung bis Klemmkasten

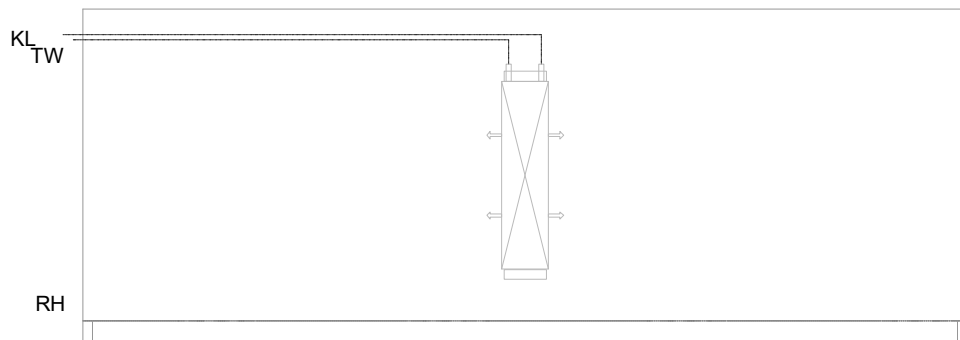
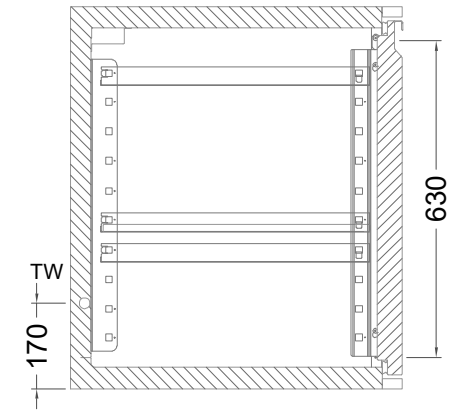
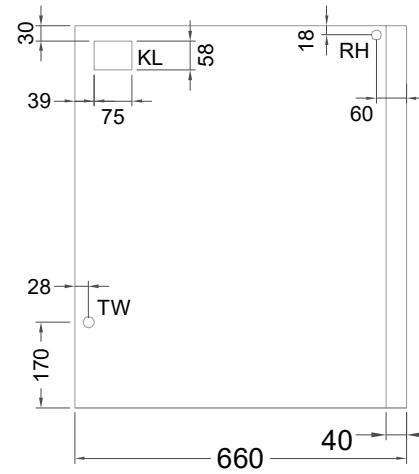
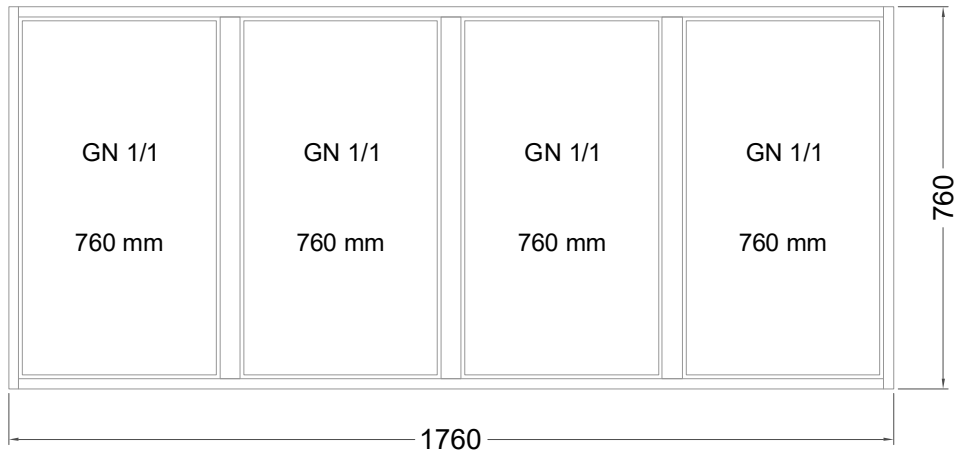

KT 4-76-xx

- * KL...Kälteleitungen
- * TW...Tauwasser - Siphon und bauseitiger Ablauf erforderlich
- * RH...Rahmenheizung

Details IDEAL-AKE Kälteregele

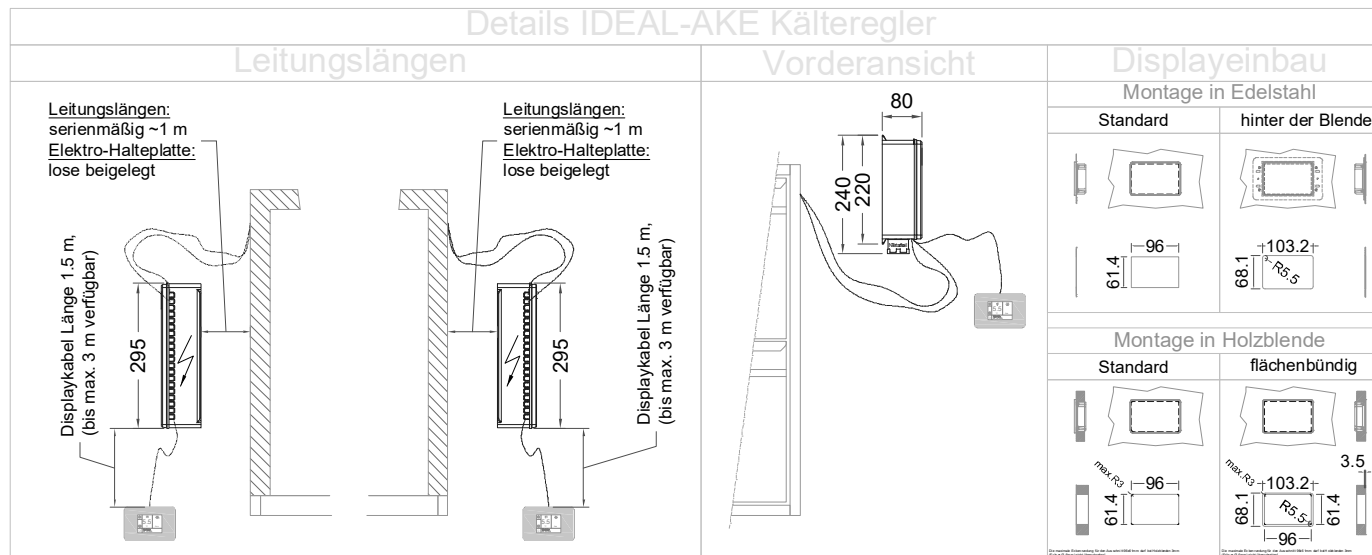

Türelement

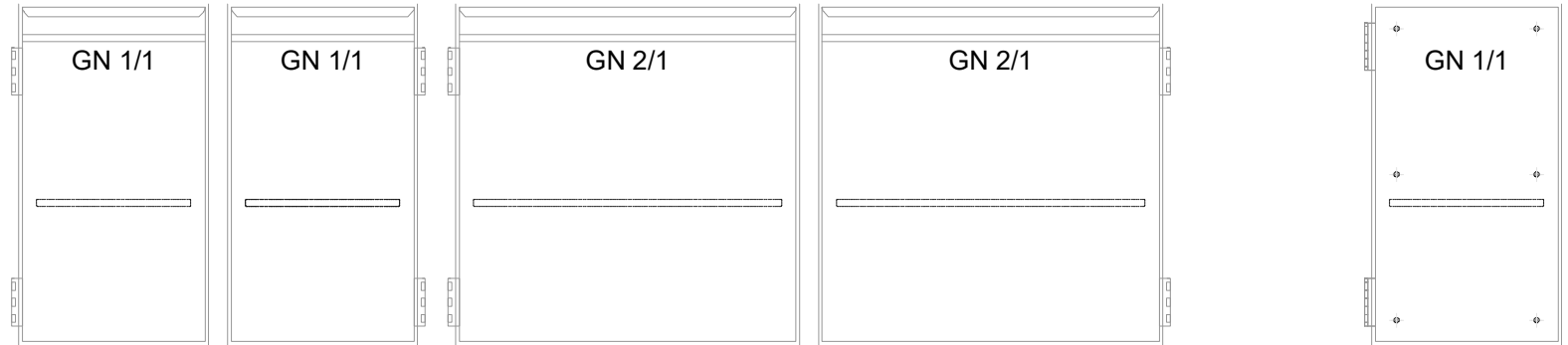
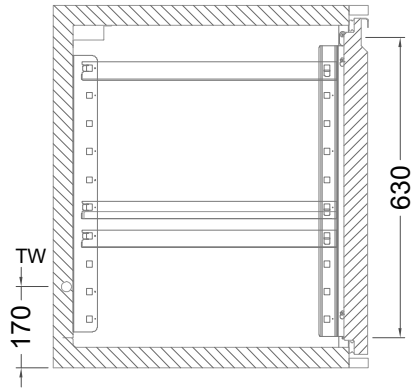

2 Züge 1/2-1/2

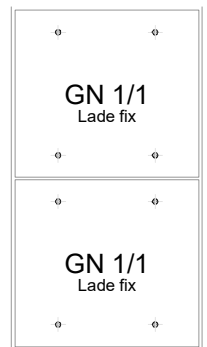
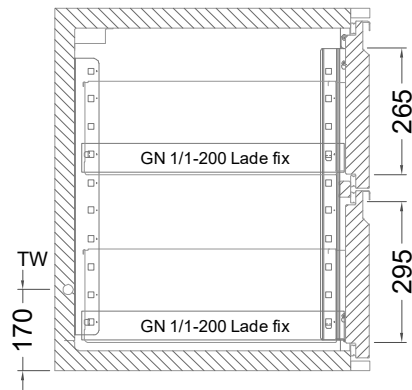

2 Züge FL (Flaschenlade)

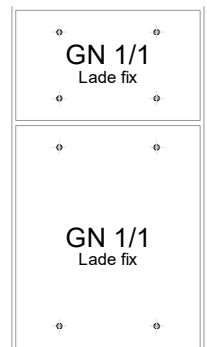
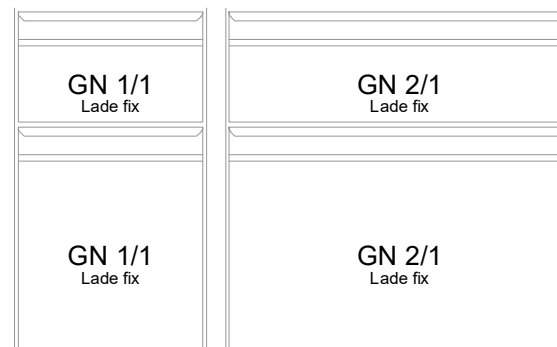
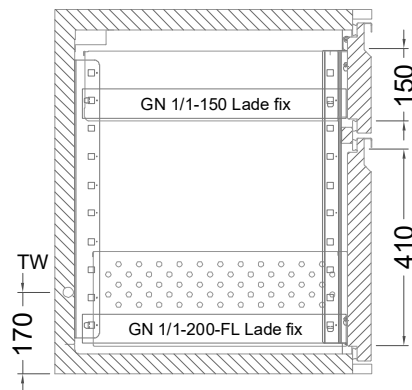

3 Züge 3x1/3

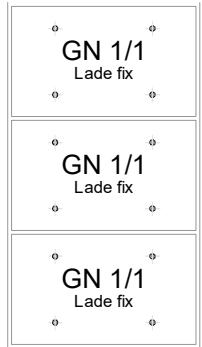
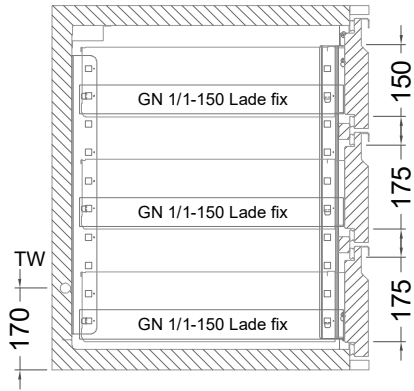

2 Züge 1/2-1/2 mit herausnehmbaren Ladeneinsätzen

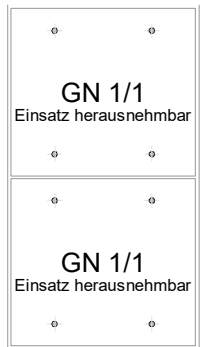
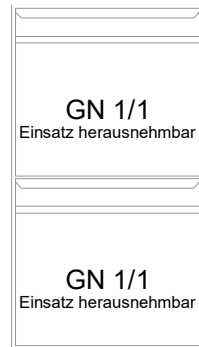
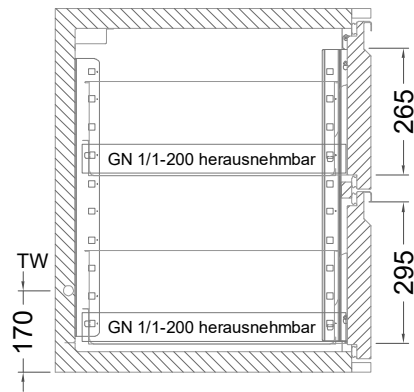

3 Züge 3x1/3 mit herausnehmbaren Ladeneinsätzen

