

Masszeichnung

Einbaukühlvitrine EPV 145-7 Front geschlossen

[Art. 484357052]

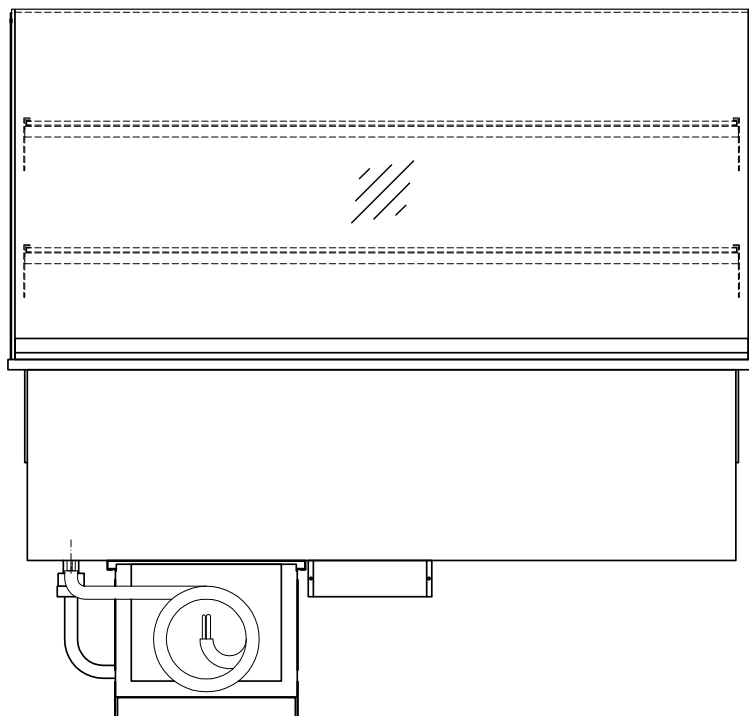

(Kundenseite)

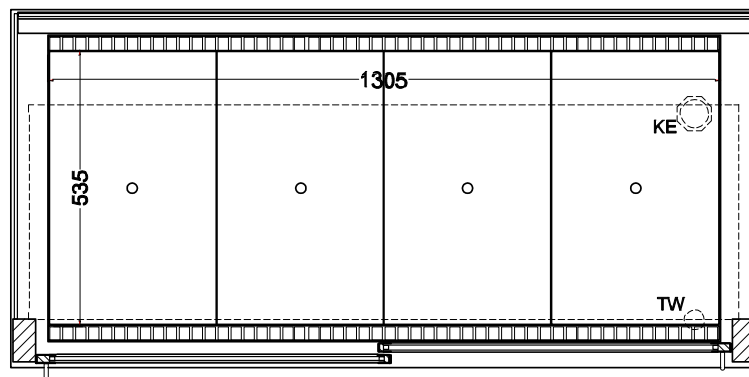

(Grundriss)

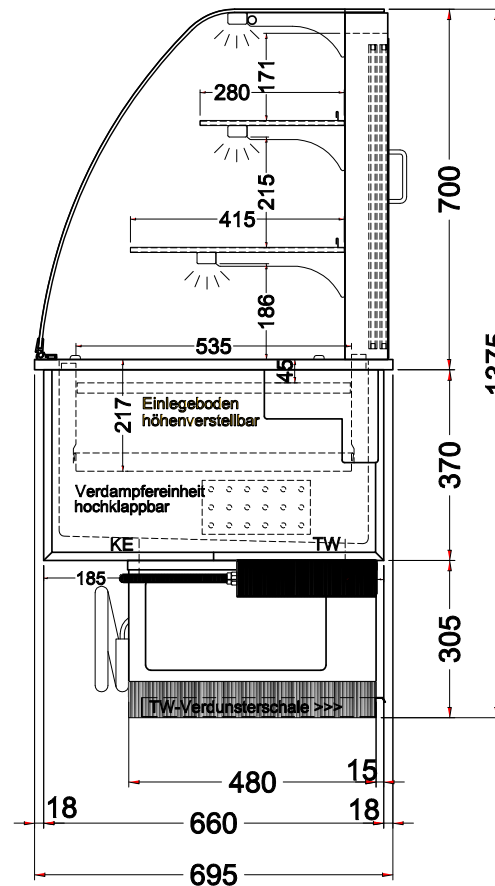
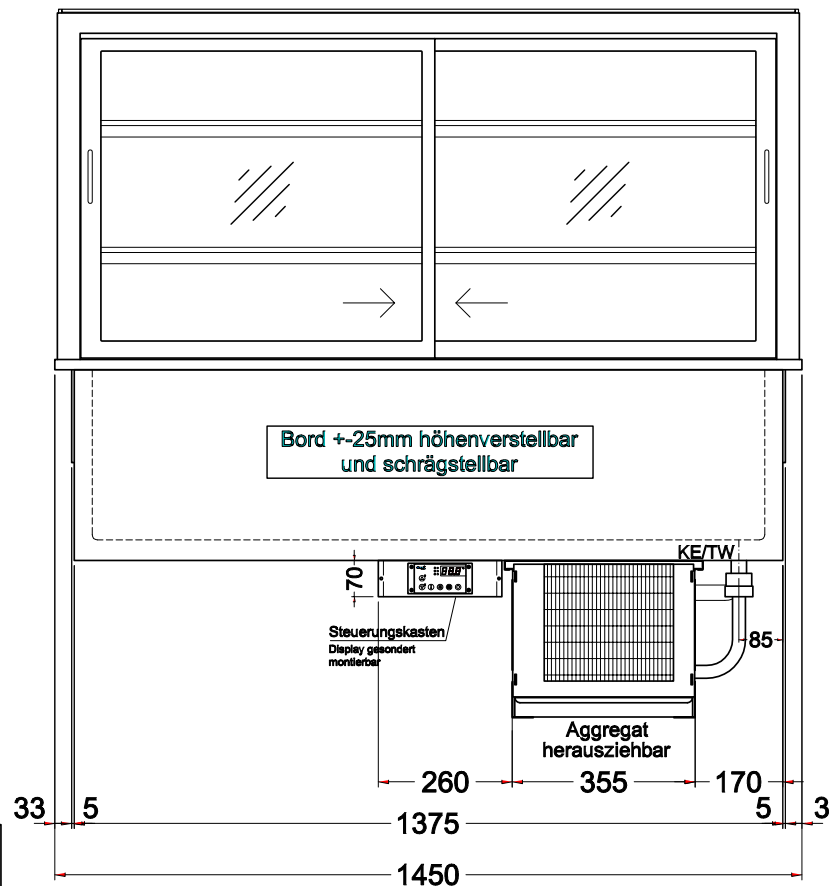

TW = Tauwasserablauf DNØ30
KE = Kälte-Elektro