

Masszeichnung

Kühltisch (4 Abteile) KTE 4-70-4T MFL (R-290)

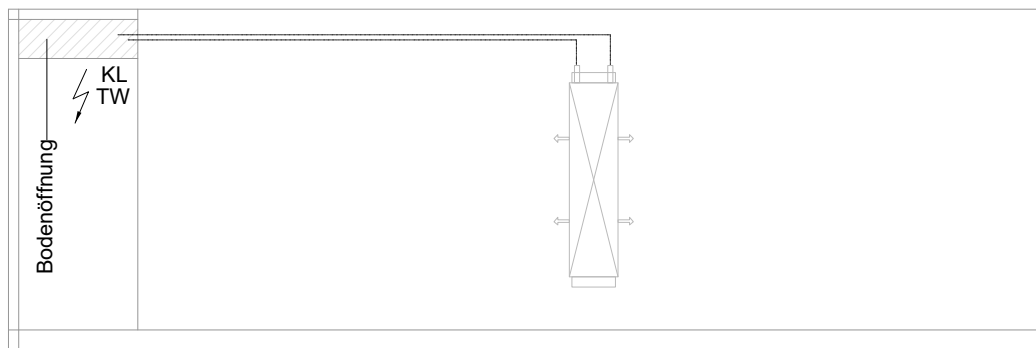
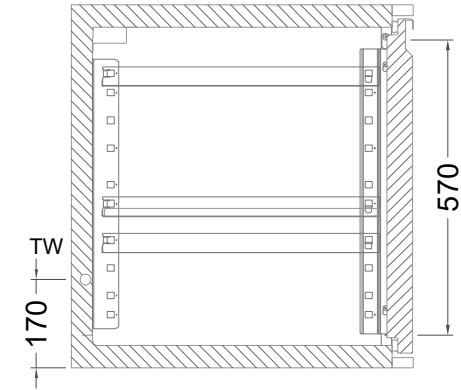
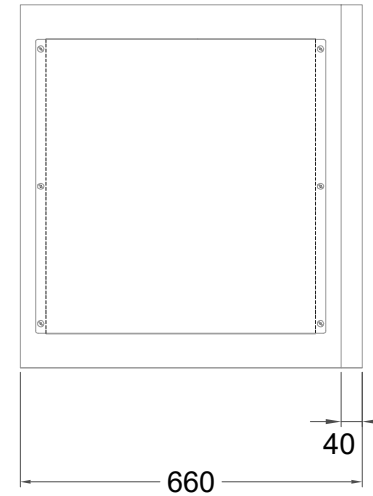
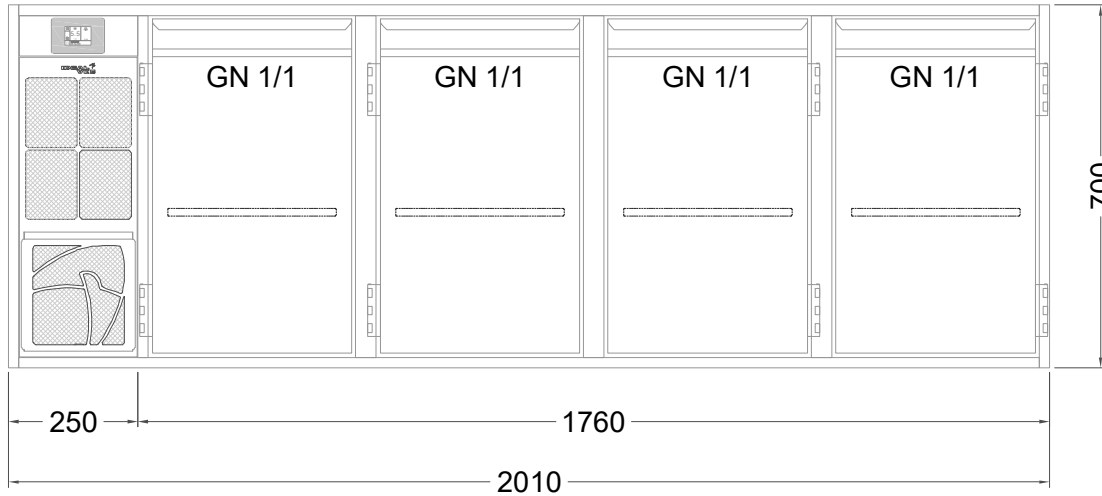

[Art.Nr.: 3100603]

KTE 4-70-4T

- * KL...Kälteleitungen
- * TW...Tauwasser - kein bauseitiger Ablauf erforderlich

Türelement

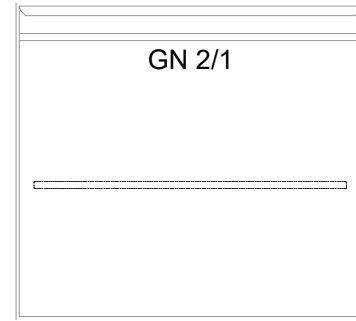
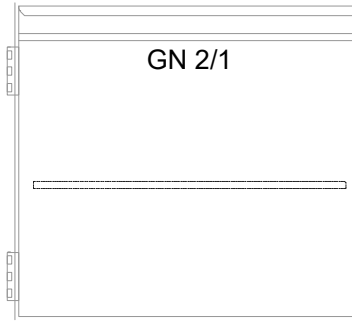
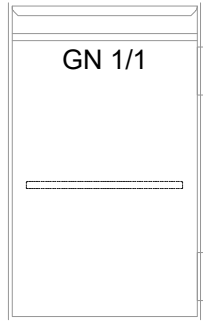
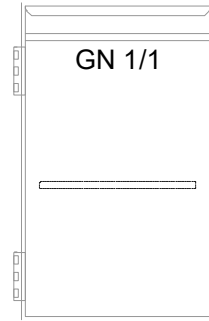
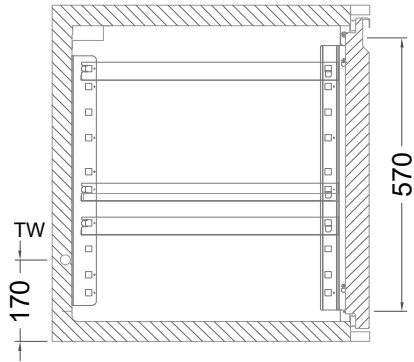

2 Züge 1/2-1/2

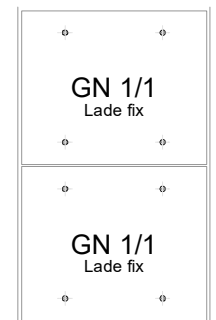
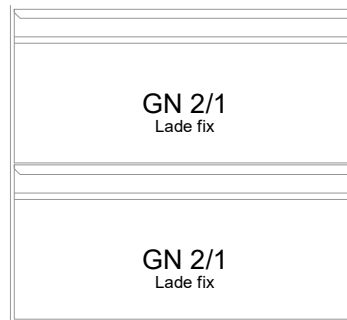
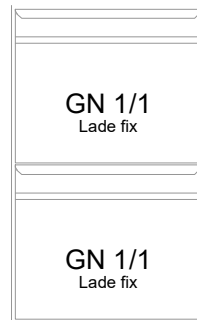
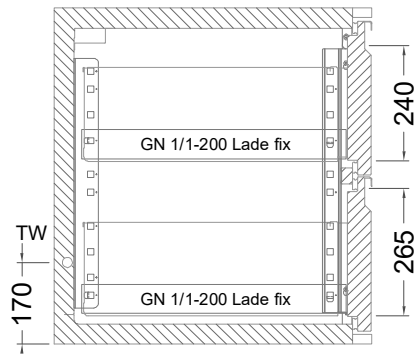

2 Züge FL (Flaschenlade)

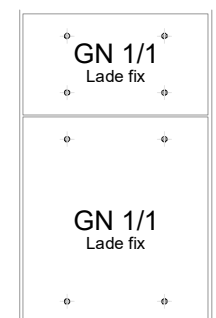
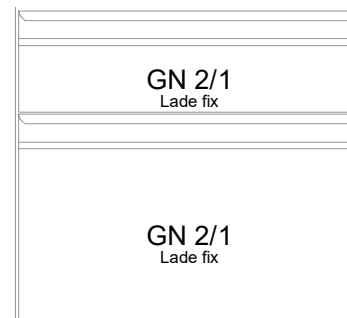
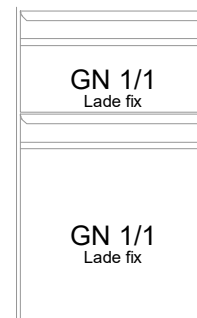
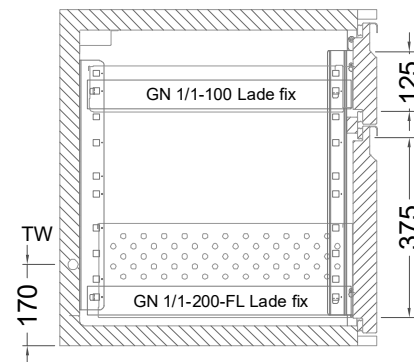

3 Züge 3x1/3

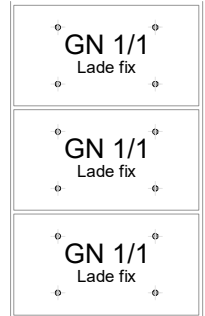
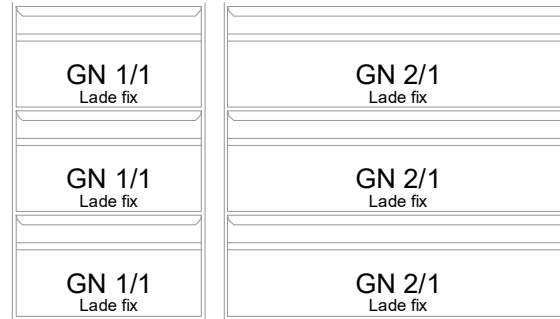
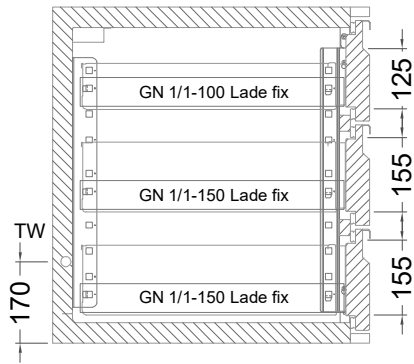

2 Züge 1/2-1/2 mit herausnehmbaren Ladeneinsätzen

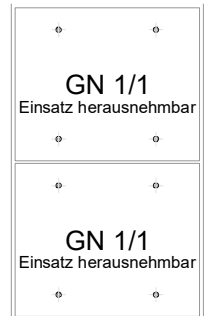
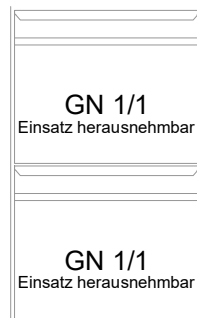
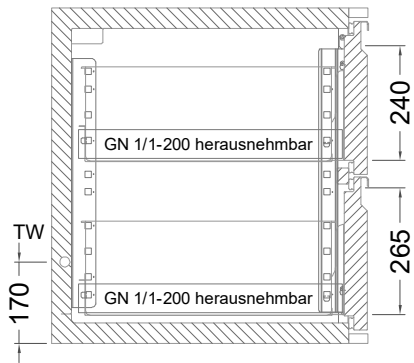

3 Züge 3x1/3 mit herausnehmbaren Ladeneinsätzen

