

Masszeichnung Salatbar TR-BLUE 3/1-UMLUFT

[Art. 434714001]

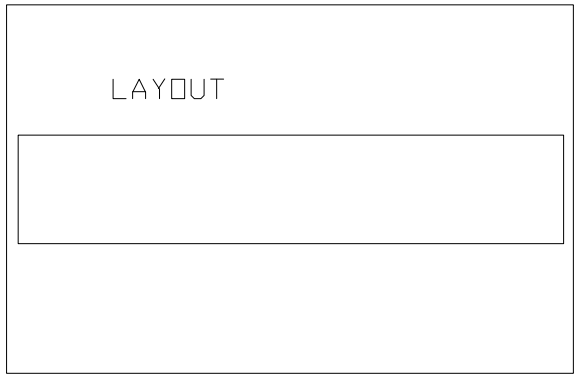
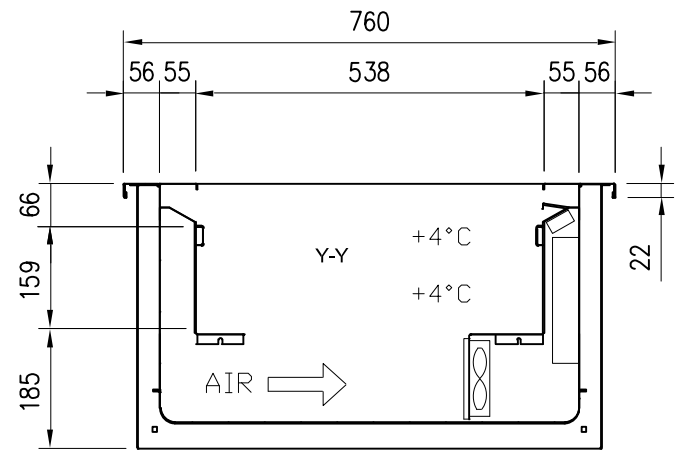
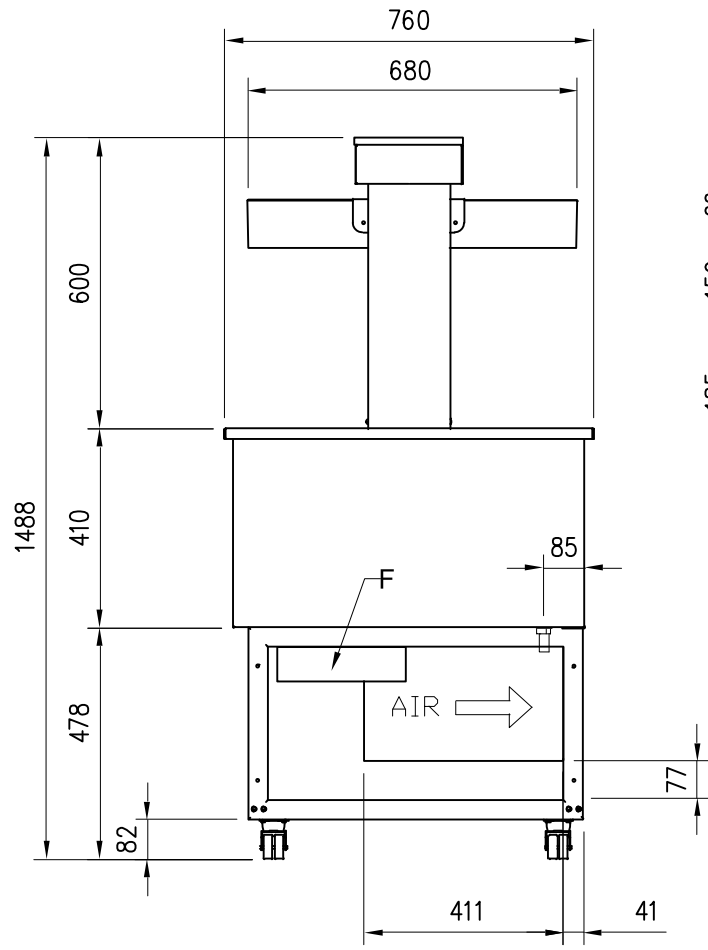
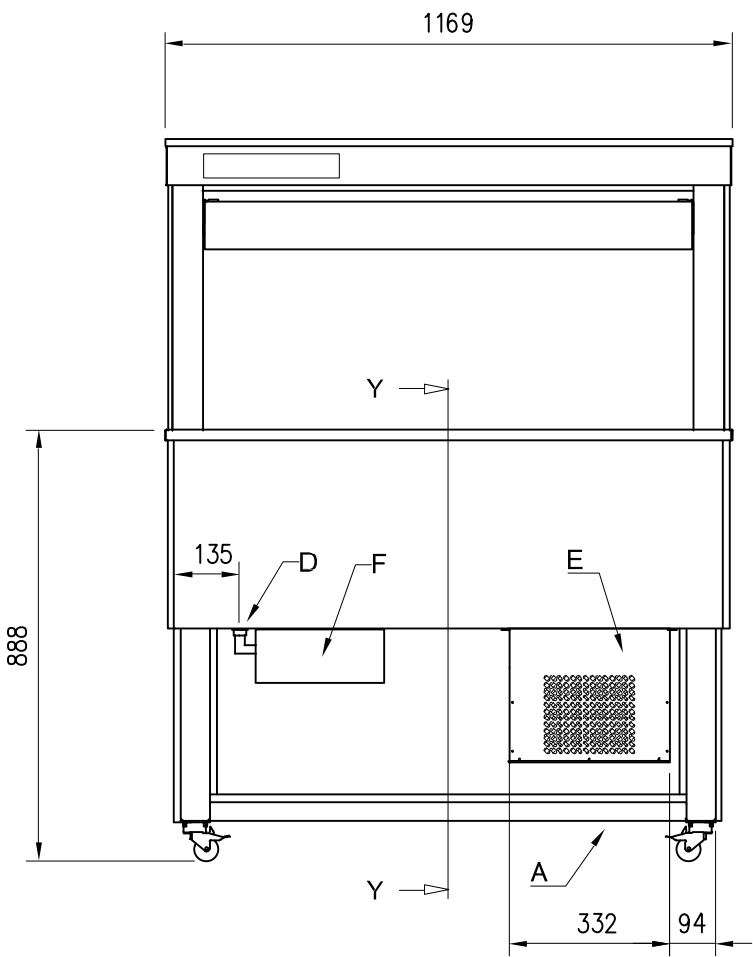

- A= ELECTRICAL CONNECTION
- D= WATER DISCHARGE $\varnothing 16$
- E= GAS CONNECTION $\varnothing 8 \varnothing 10$
- F= WATER BOX