

# Masszeichnung

## Kühltisch (4 Abteile) KTE 4-76-4T MFL (R-290)

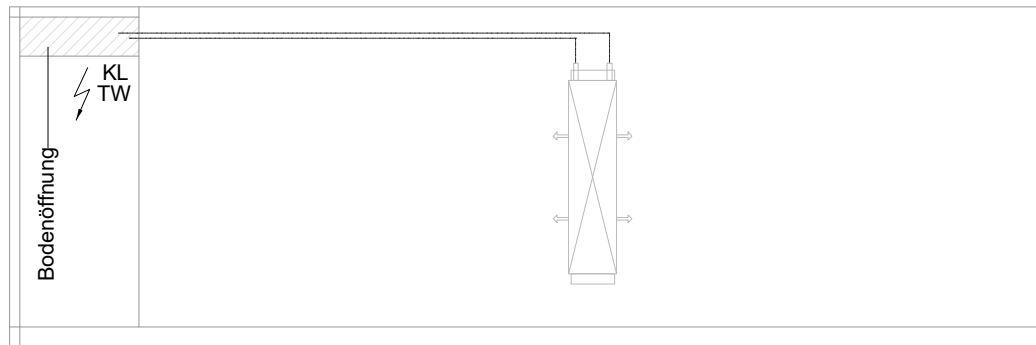
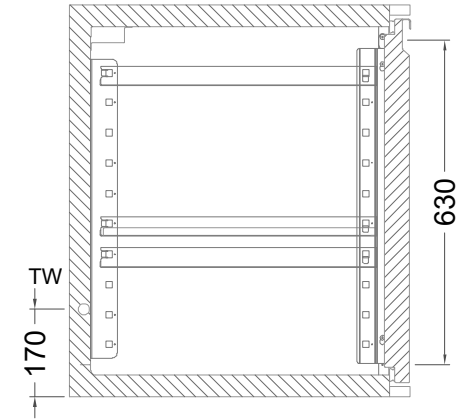
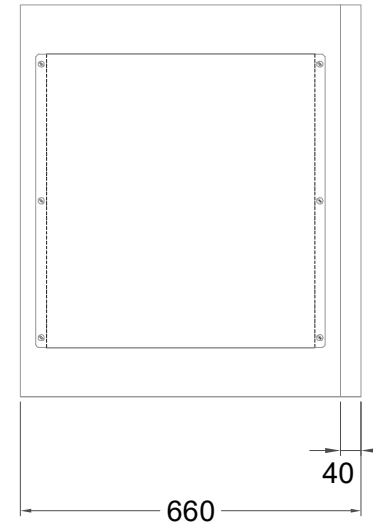
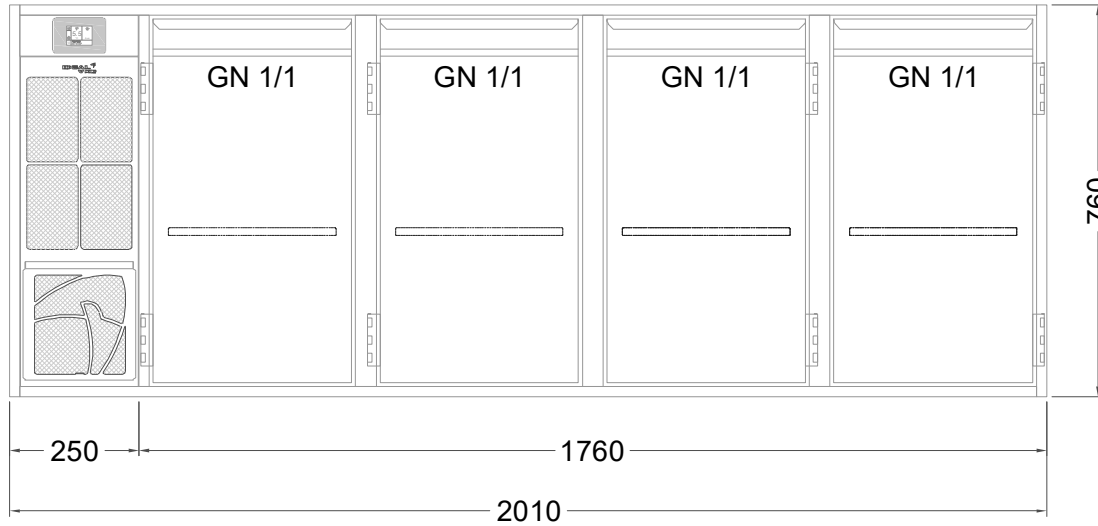

[Art.Nr.: 31000607]

**KTE 4-76-4T**

- \* KL...Kälteleitungen
- \* TW...Tauwasser - kein bauseitiger Ablauf erforderlich

## Türelement

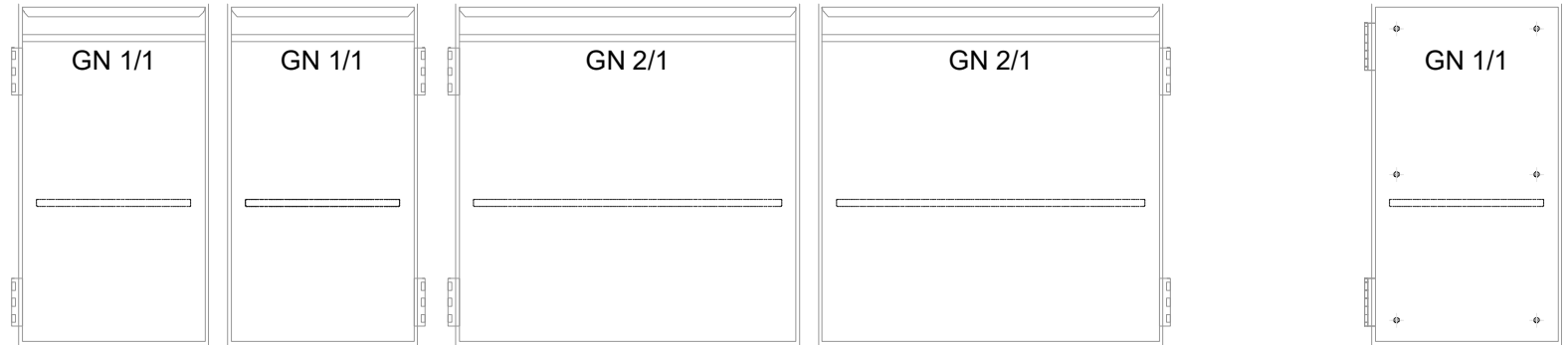
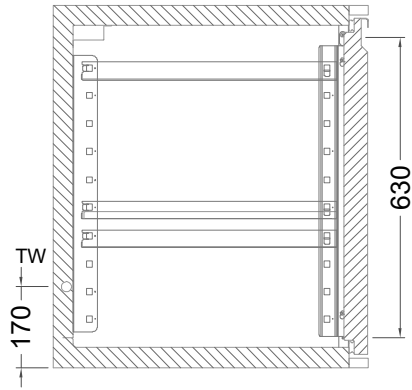

## 2 Züge 1/2-1/2

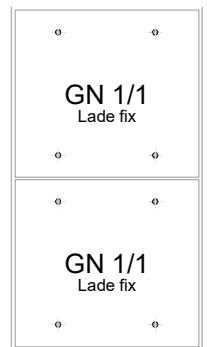
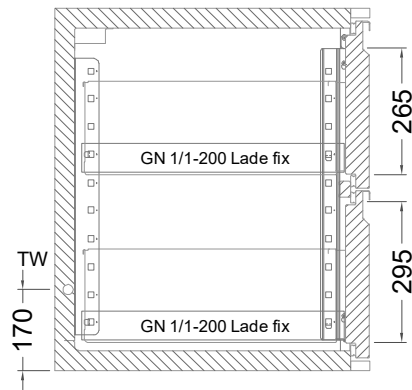

## 2 Züge FL (Flaschenlade)

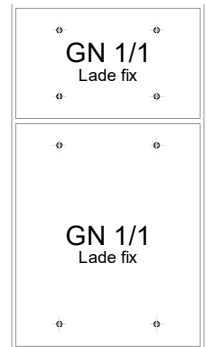
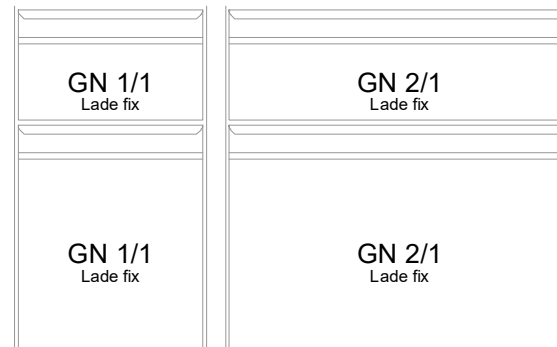
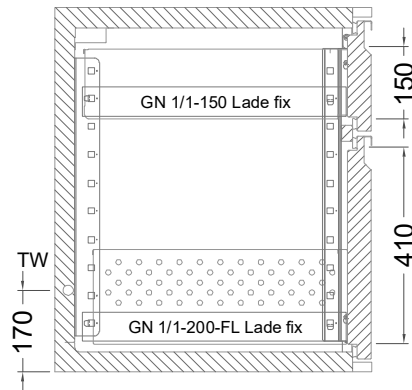

### 3 Züge 3x1/3

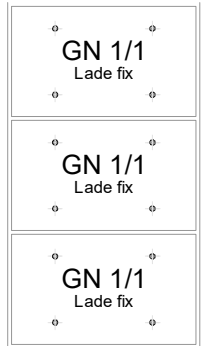
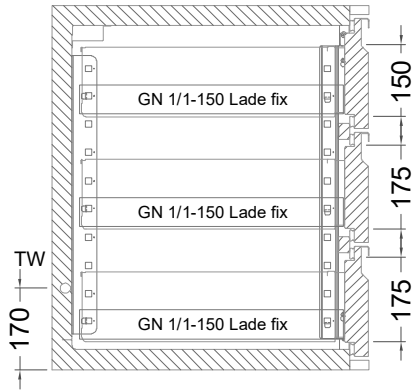

### 2 Züge 1/2-1/2 mit herausnehmbaren Ladeneinsätzen

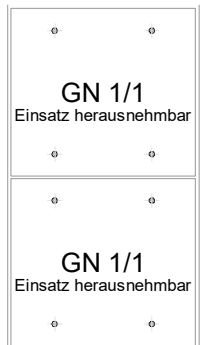
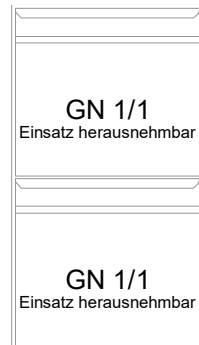
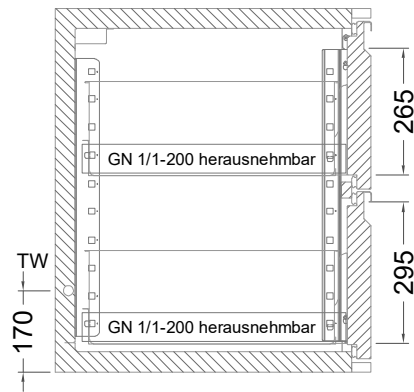

### 3 Züge 3x1/3 mit herausnehmbaren Ladeneinsätzen

