

# Masszeichnung

## Backwarenkühltisch BKE 3-71-3T MFR (R-290)

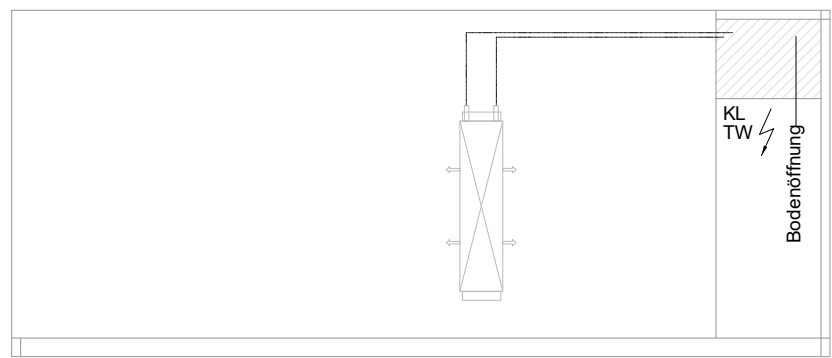
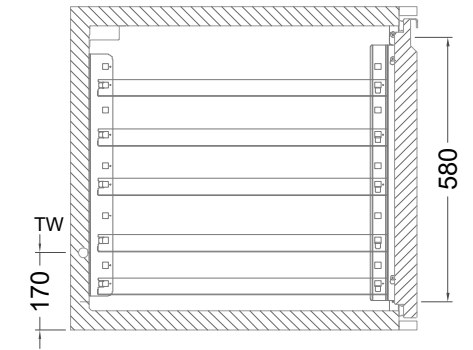
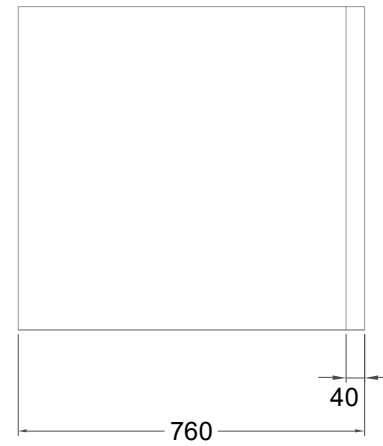

[Art.Nr.: 31000702]  
**BKE 3-71-3T**

- \* KL...Kälteleitungen
- \* TW...Tauwasser - in der Rückwand geführt, selbstständige Verdunstung über Aggregatabwärme, kein bauseitiger Ablauf erforderlich
- \* ⚡ Elektroanschluss