

# Masszeichnung

## Kühltisch (2 Abteile) UBZ 2-51-2T I FL (zentralgekuehlt)

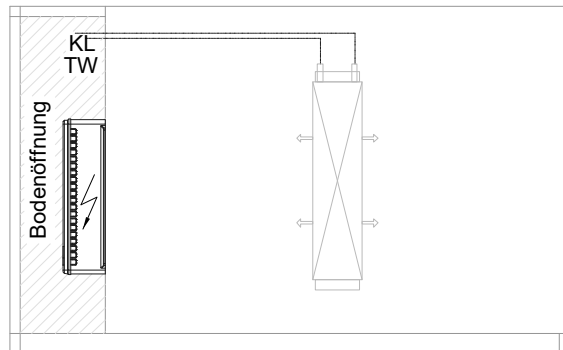
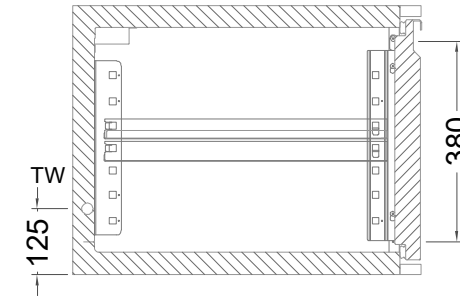
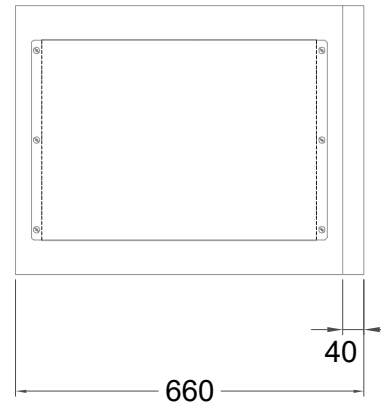
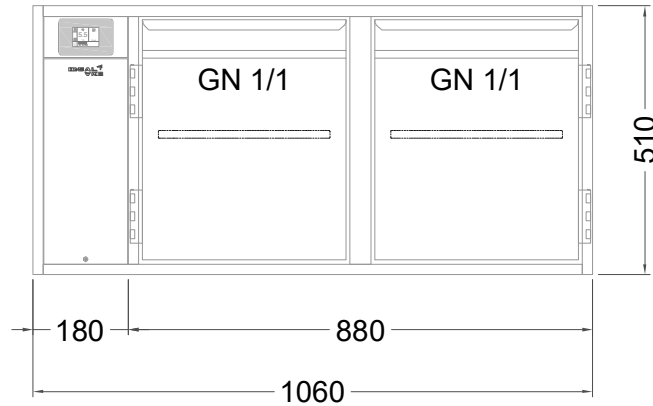

[Art.Nr.: 31000625]

**UBZ 2-51-2T**

- \* KL...Kälteleitungen
- \* TW...Tauwasser - bauseitiger Siphon und Ablauf erforderlich
- \* ⚡ Verdrahtung bis Klemmkasten

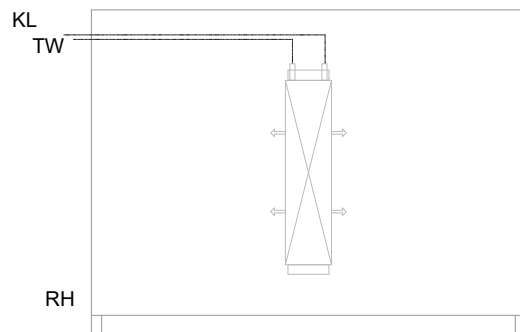
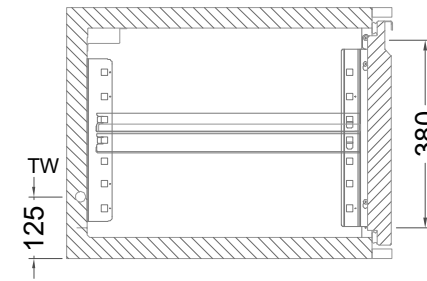
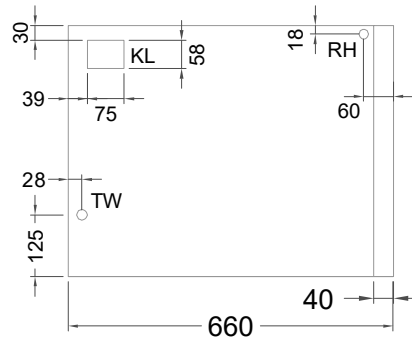
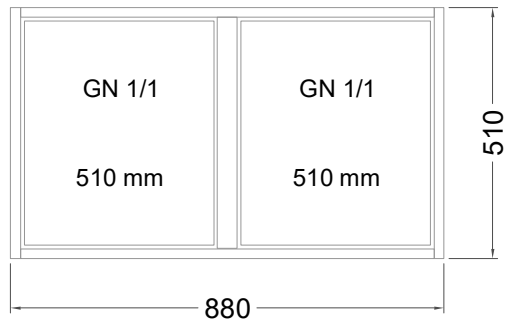

UB 2-51-xx

- \* KL...Kälteleitungen
- \* TW...Tauwasser - Siphon und bauseitiger Ablauf erforderlich
- \* RH...Rahmenheizung

## Details IDEAL-AKE Kälteregele

### Leitungslängen

**Leitungslängen:**  
serienmäßig ~1 m  
**Elektro-Halteplatte:**  
lose beigelegt

Displaykabel Länge 1.5 m,  
(bis max. 3 m verfügbar)

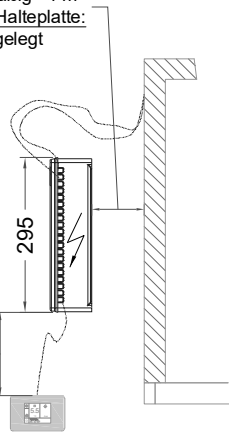

**Leitungslängen:**  
serienmäßig ~1 m  
**Elektro-Halteplatte:**  
lose beigelegt

Displaykabel Länge 1.5 m,  
(bis max. 3 m verfügbar)

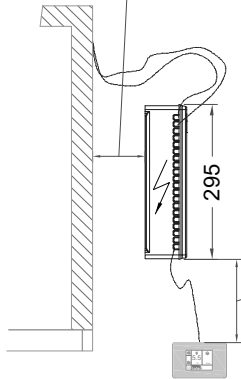

### Vorderansicht

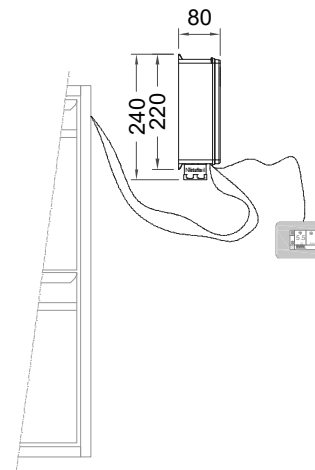

### Displayeinbau

#### Montage in Edelstahl

##### Standard

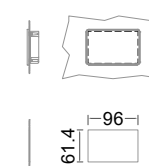

##### hinters der Blende

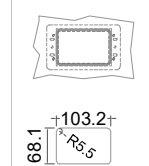

#### Montage in Holzblende

##### Standard

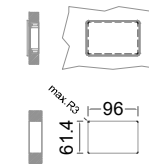

##### flächenbündig

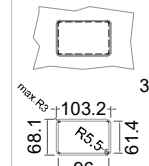

## Türelement

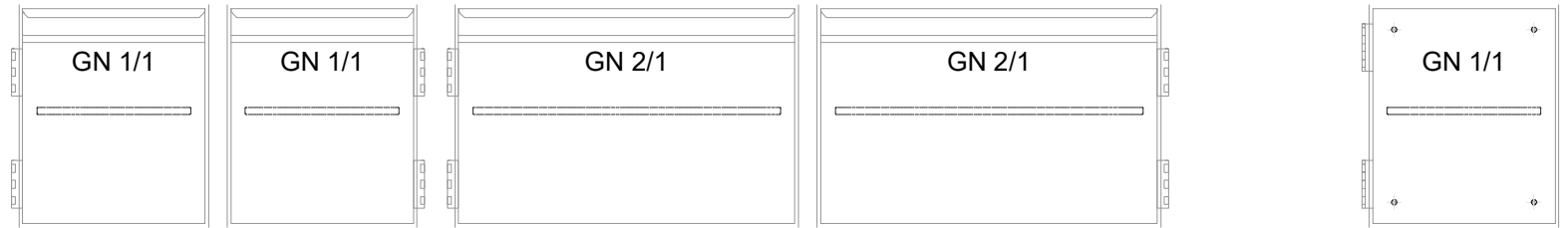
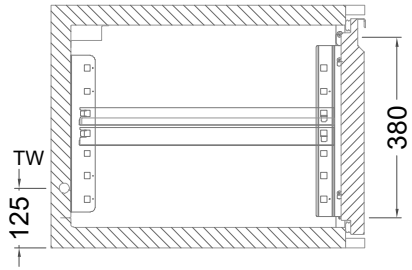

## 1 Zug

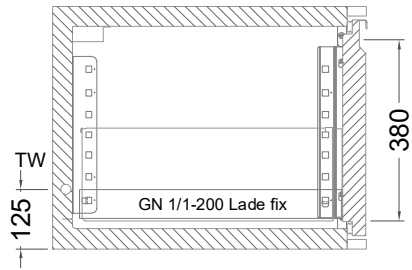

## 2 Züge 1/2-1/2

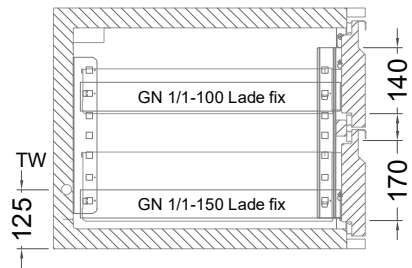

### 1 Zug mit herausnehmbarem Ladeneinsatz

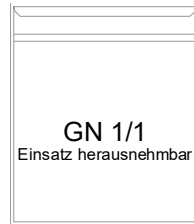
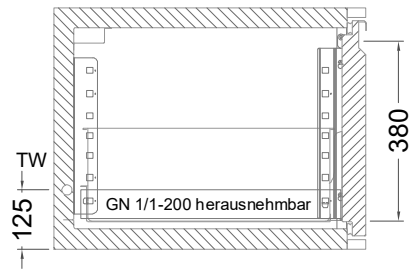

### 2 Züge 1/2-1/2 mit herausnehmbaren Ladeneinsätzen

