

Masszeichnung

Backwarenkühltisch UBKZ 3-46-3T IFL (zentralgekuehlt)

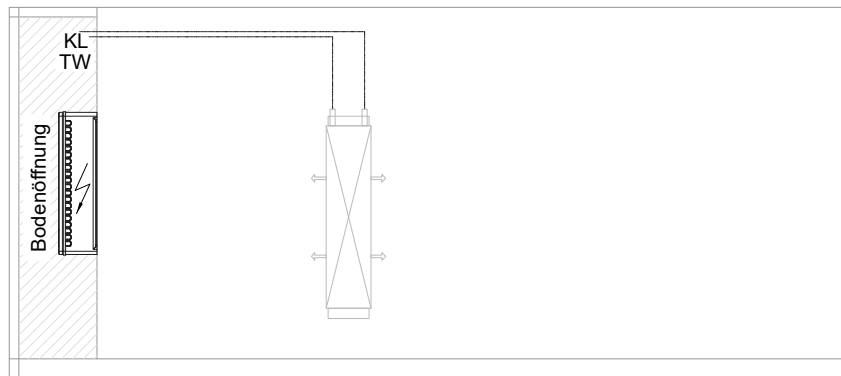
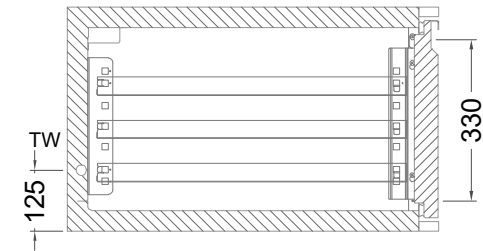
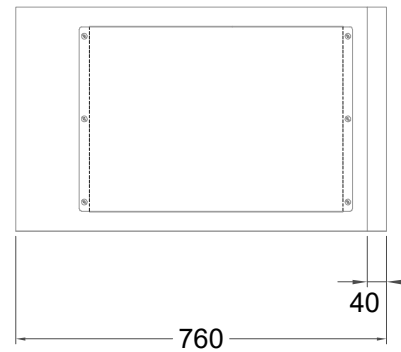
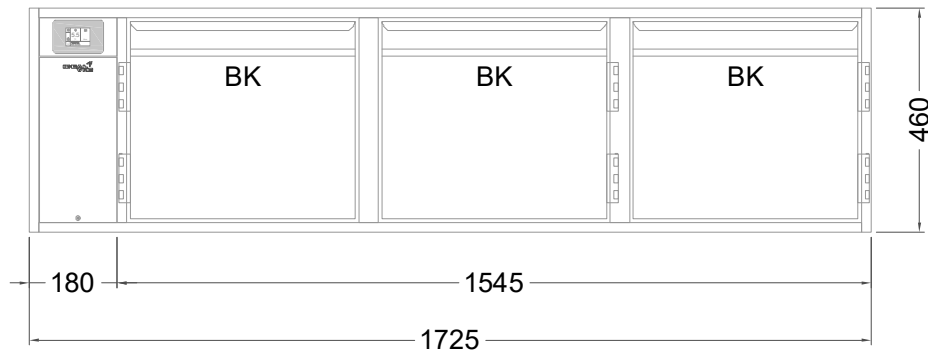

[Art.Nr.: 3100749]

UBKZ 3-46-3T

- * KL...Kälteleitungen
- * TW...Tauwasser - bauseitiger Siphon und Ablauf erforderlich
- * ⚡ Elektroanschluss