

Masszeichnung

Backwarenkühltisch UBKE 2-56-2T MFL (R-290)

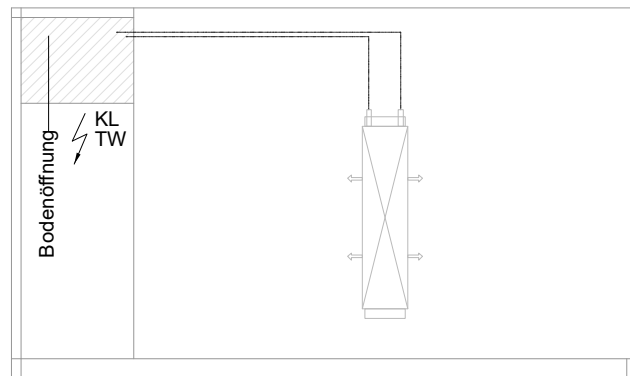
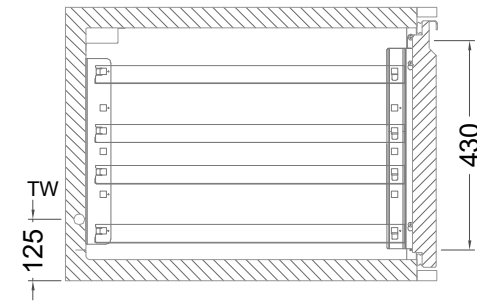
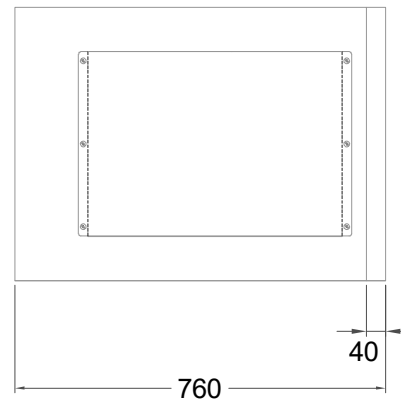
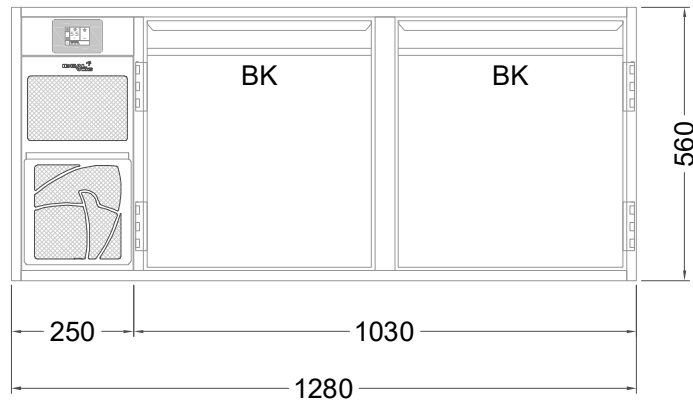

[Art.Nr.: 31000683]

UBKE 2-56-2T

- * KL...Kälteleitungen
- * TW...Tauwasser - in der Rückwand geführt, selbstständige Verdunstung über Aggregatabwärme, kein bauseitiger Ablauf erforderlich
- * ⚡ Elektroanschluss