

Masszeichnung

Backwarenkühltisch BKE 2-70-2T MFL (R-290)

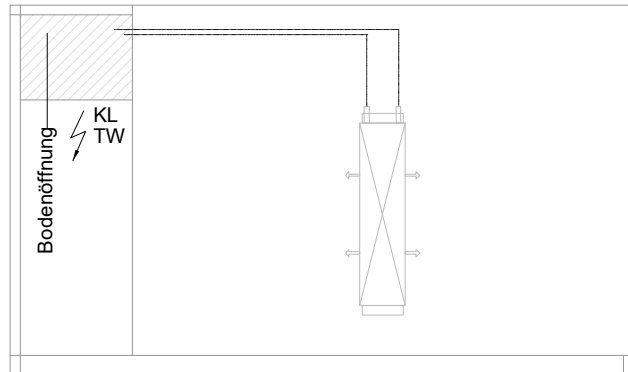
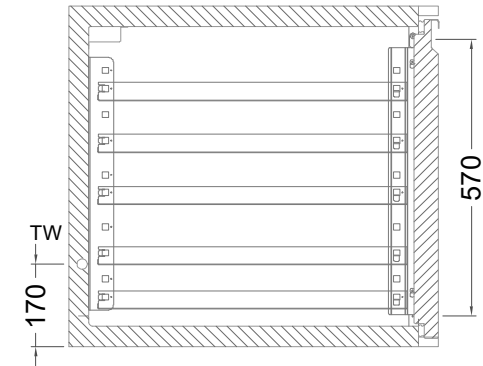
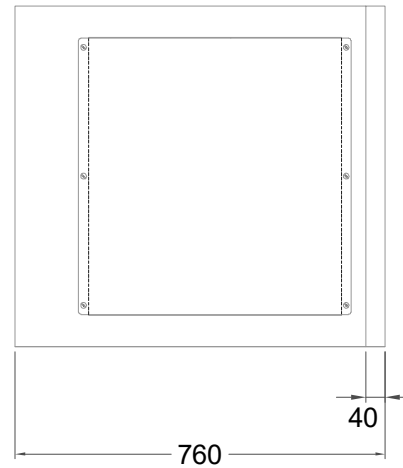
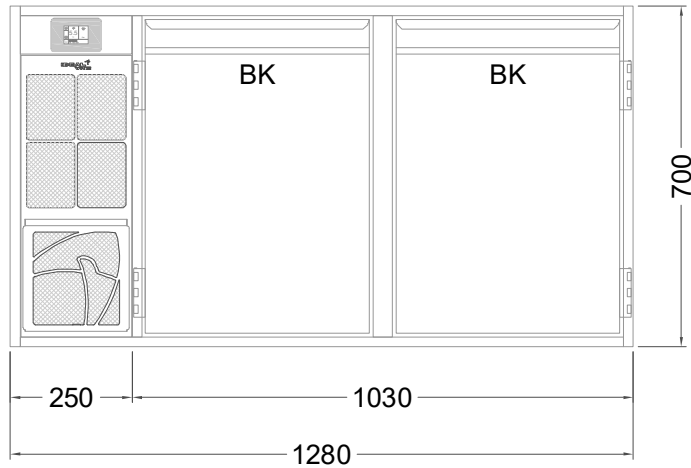

[Art.Nr.: 31000687]

BKE 2-70-2T

- * KL...Kälteleitungen
- * TW...Tauwasser - in der Rückwand geführt, selbstständige Verdunstung über Aggregatabwärme, kein bauseitiger Ablauf erforderlich
- * ⚡ Elektroanschluss