

# Masszeichnung

## Kühltisch (3 Abteile) KTE 3-71-3T MFL (R-290)

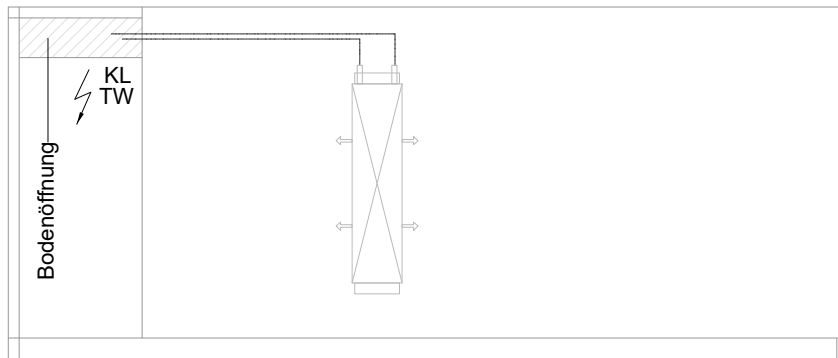
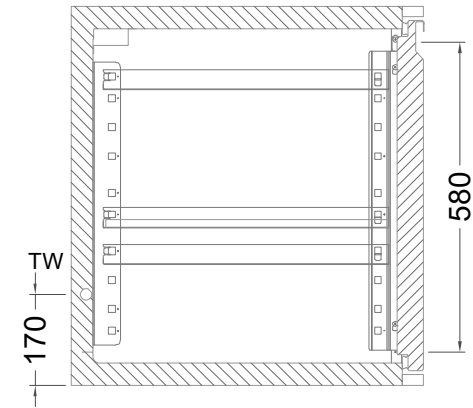
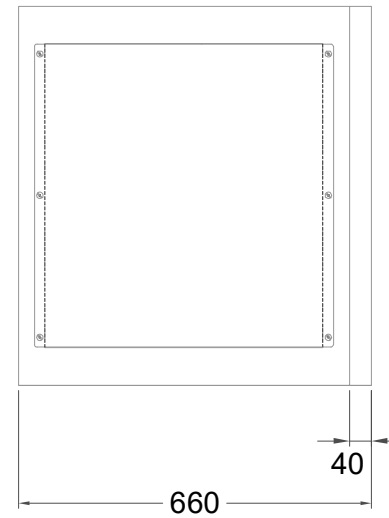
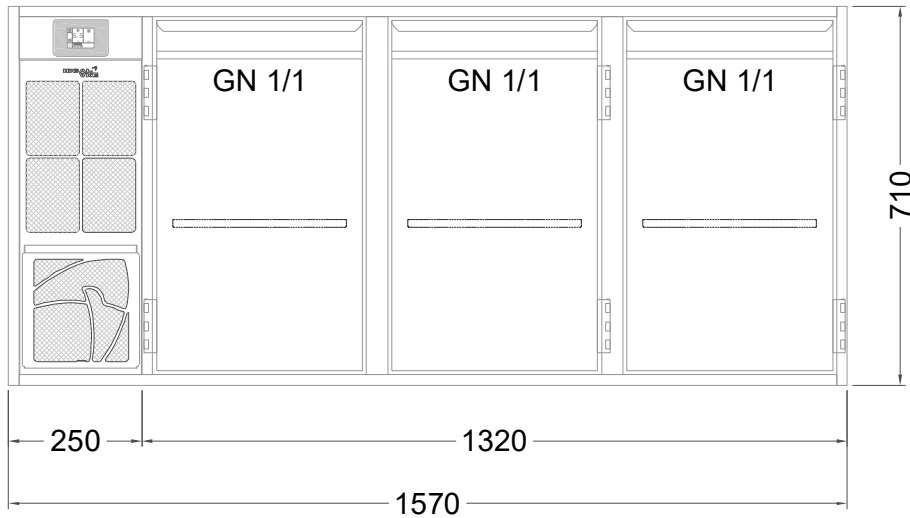

[Art.Nr.: 31000591]

**KTE 3-71-3T**

- \* KL...Kälteleitungen
- \* TW...Tauwasser - kein bauseitiger Ablauf erforderlich

## Türelement

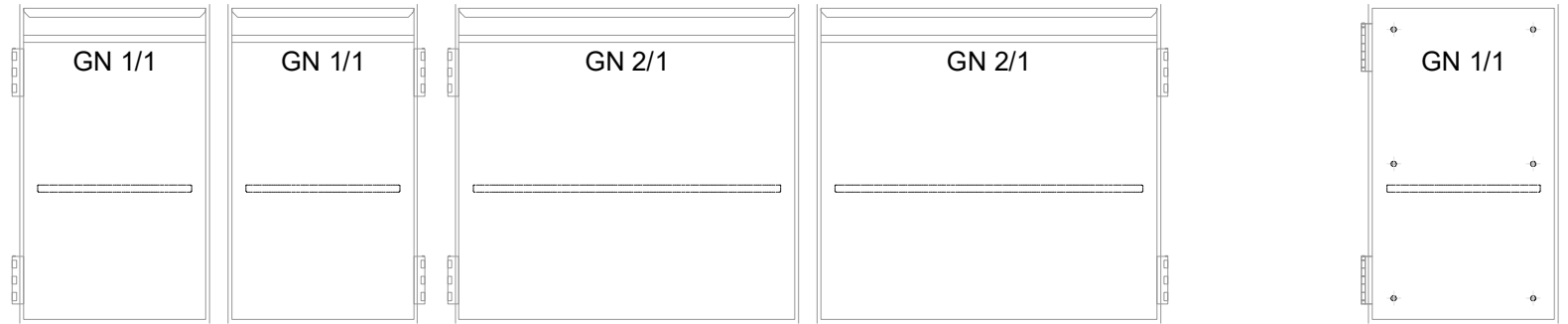
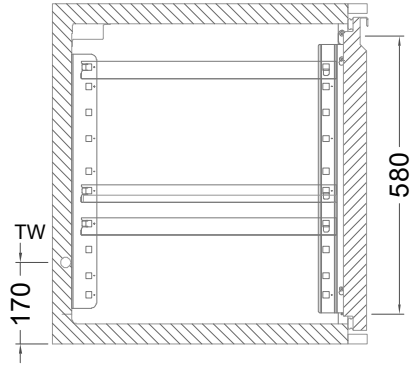

## 2 Züge 1/2-1/2

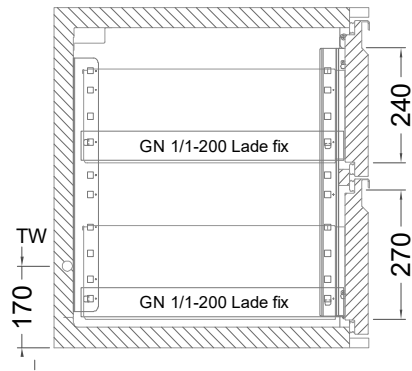

## 2 Züge FL (Flaschenlade)

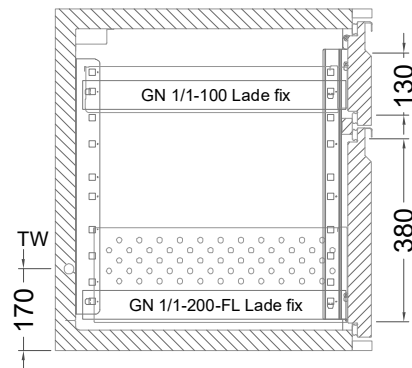

### 3 Züge 3x1/3

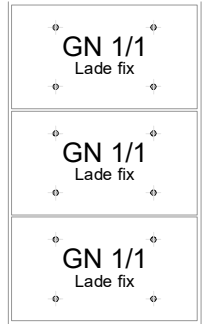
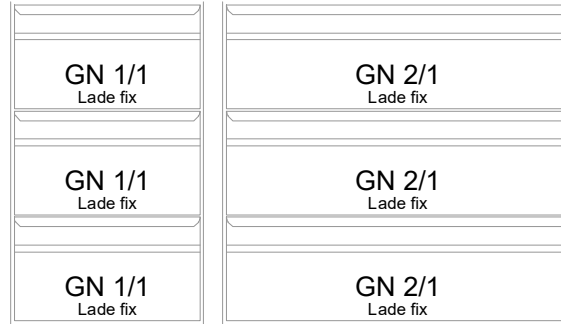
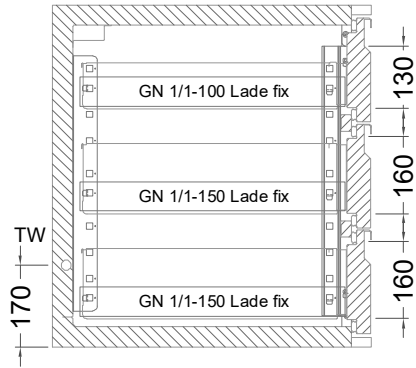

### 2 Züge 1/2-1/2 mit herausnehmbaren Ladeneinsätzen

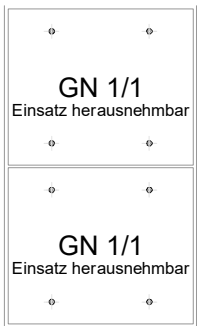
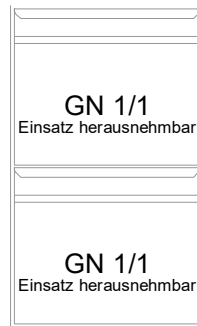
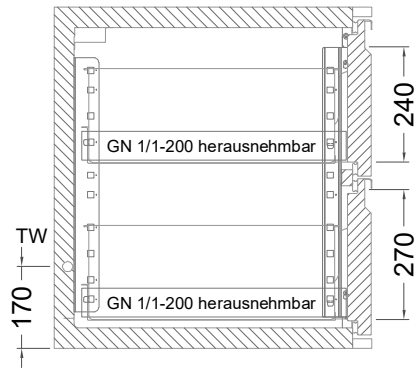

### 3 Züge 3x1/3 mit herausnehmbaren Ladeneinsätzen

