

# Masszeichnung

## Backwarenkühltisch BKE 4-70-4T MFL (R-290)

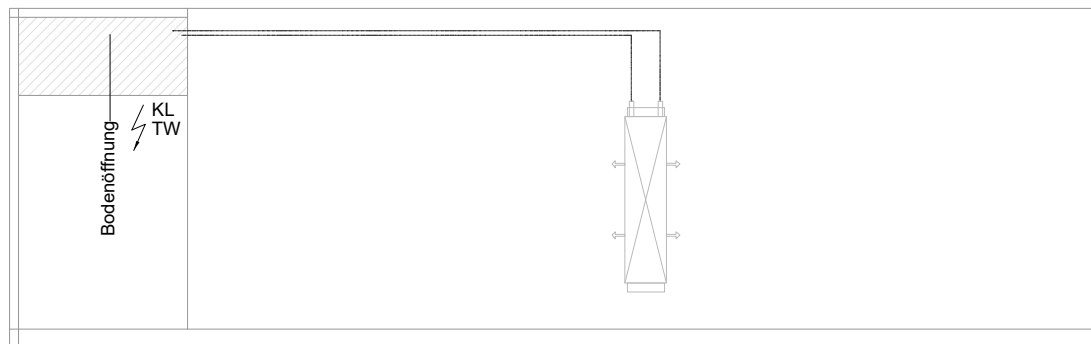
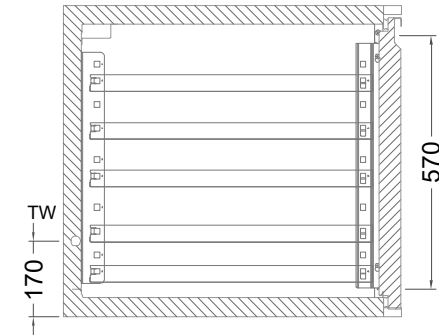
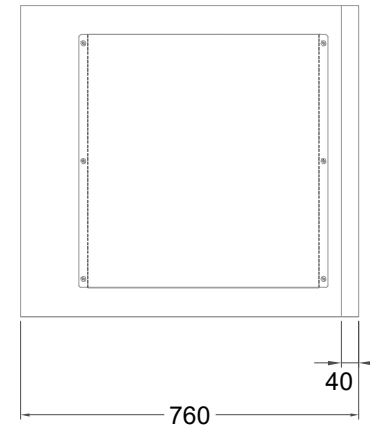
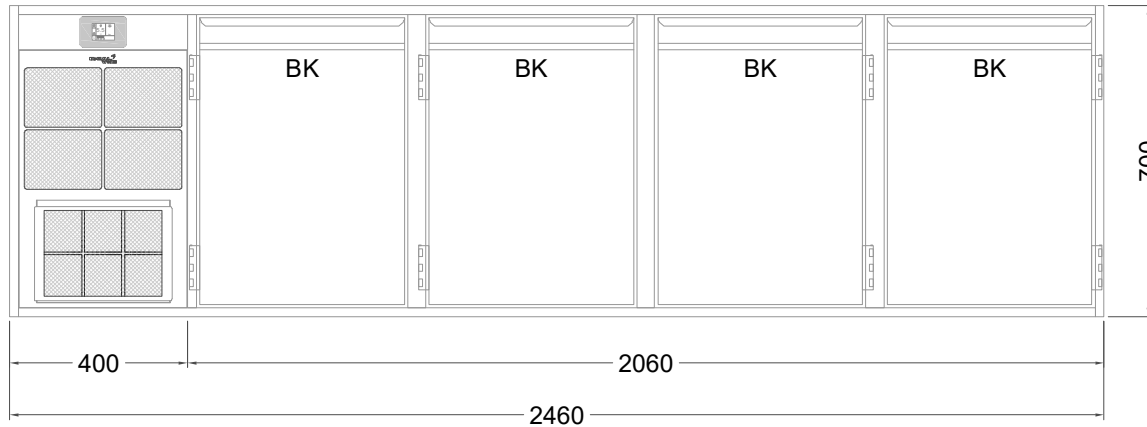

[Art.Nr.: 31000715]

**BKE 4-70-4T**

- \* KL...Kälteleitungen
- \* TW...Tauwasser - in der Rückwand geführt, selbstständige Verdunstung über Aggregatabwärme, kein bauseitiger Ablauf erforderlich
- \* ⚡ Elektroanschluss