

Masszeichnung

Kühltisch (3 Abteile) KTZ 3-76-3T I FL (zentralgekuehlt)

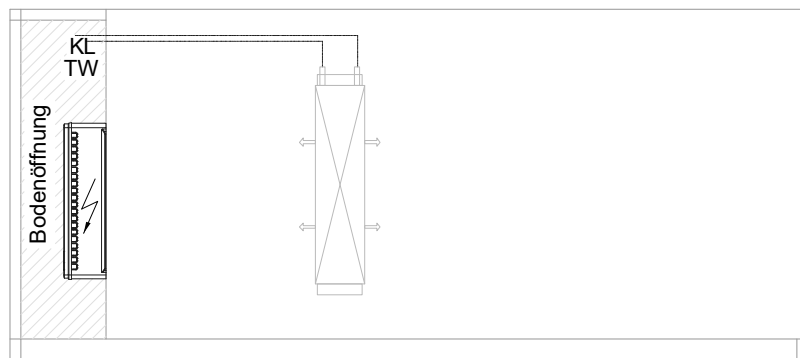
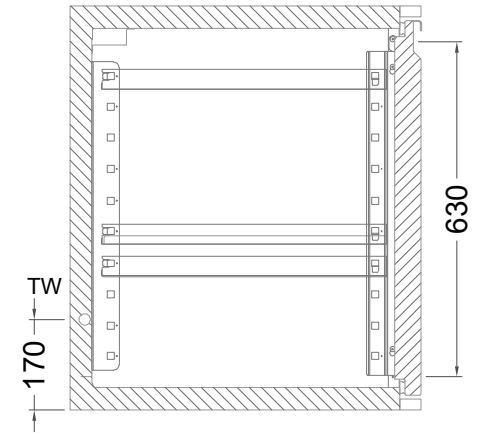
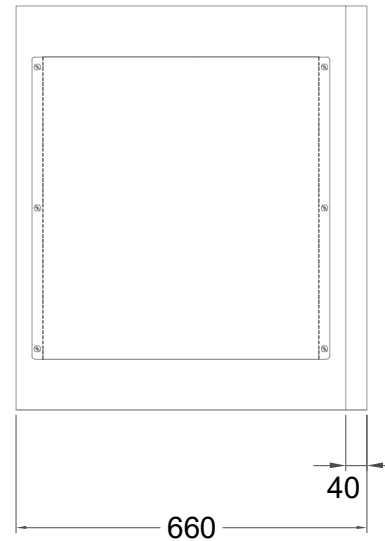

[Art.Nr.: 31000649]

KTZ 3-76-3T

- * KL...Kälteleitungen
- * TW...Tauwasser - bauseitiger Siphon und Ablauf erforderlich
- * ⚡ Verdrahtung bis Klemmkasten

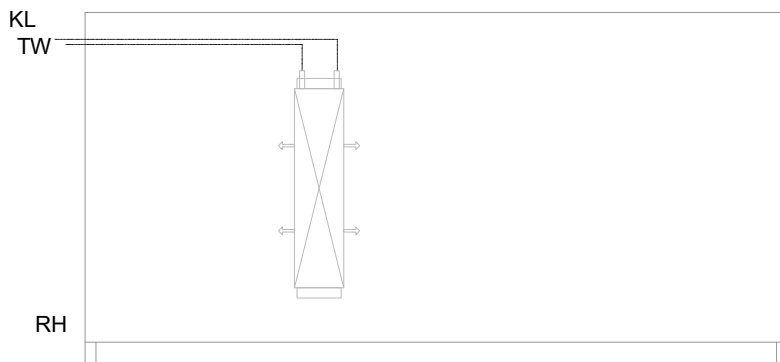
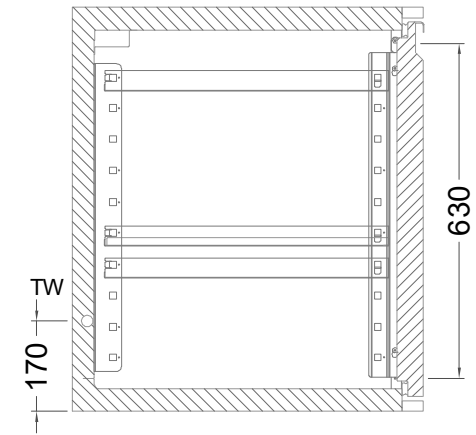
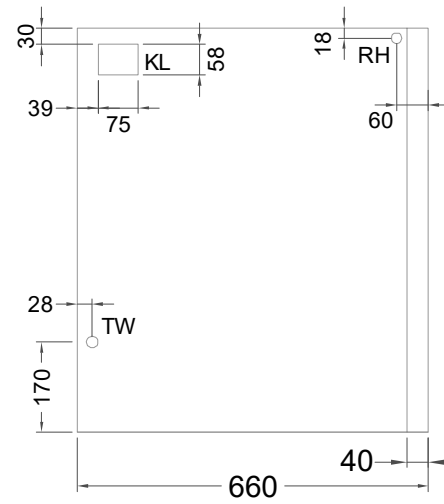
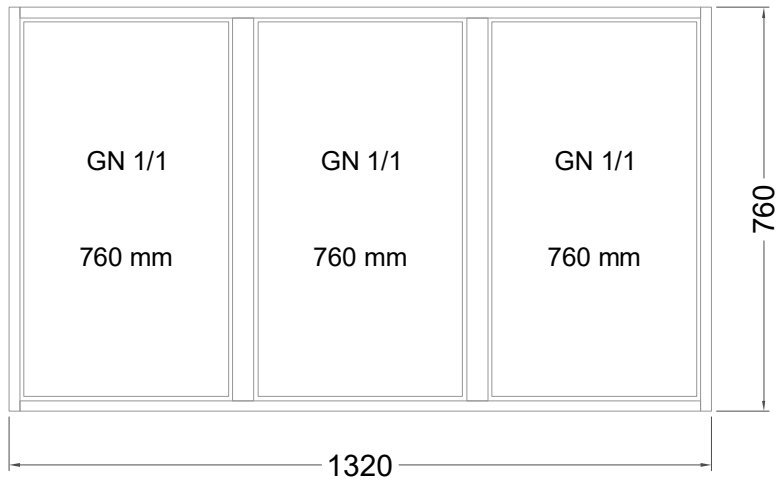

KT 3-76-xx

- * KL...Kälteleitungen
- * TW...Tauwasser - Siphon und bauseitiger Ablauf erforderlich
- * RH...Rahmenheizung

Details IDEAL-AKE Kälteregele

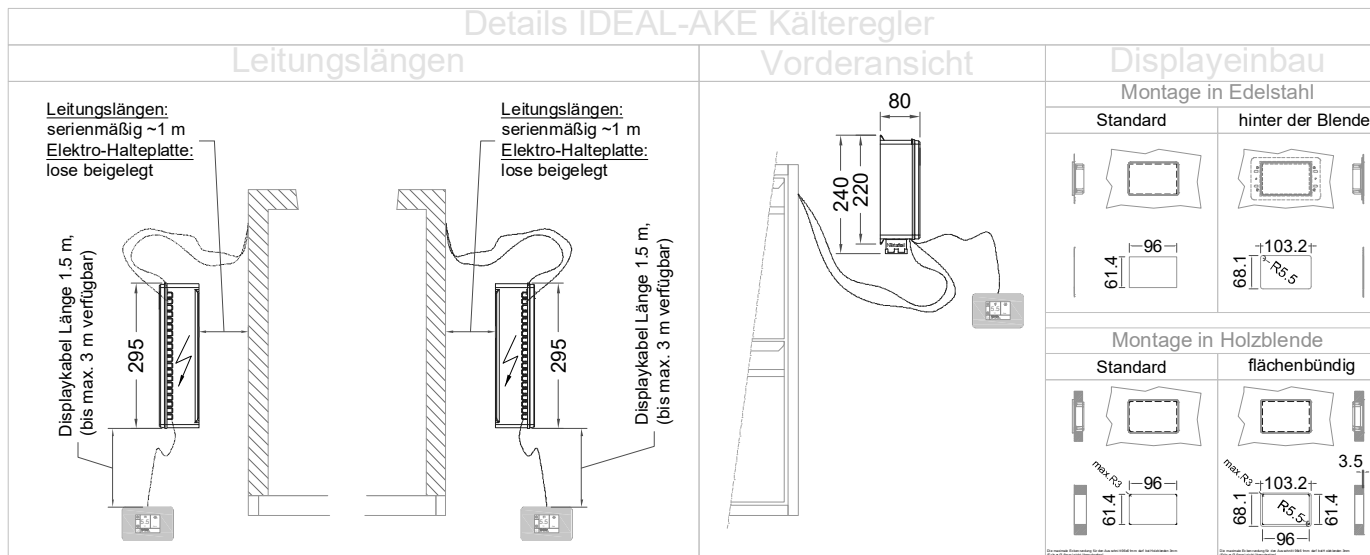

Türelement

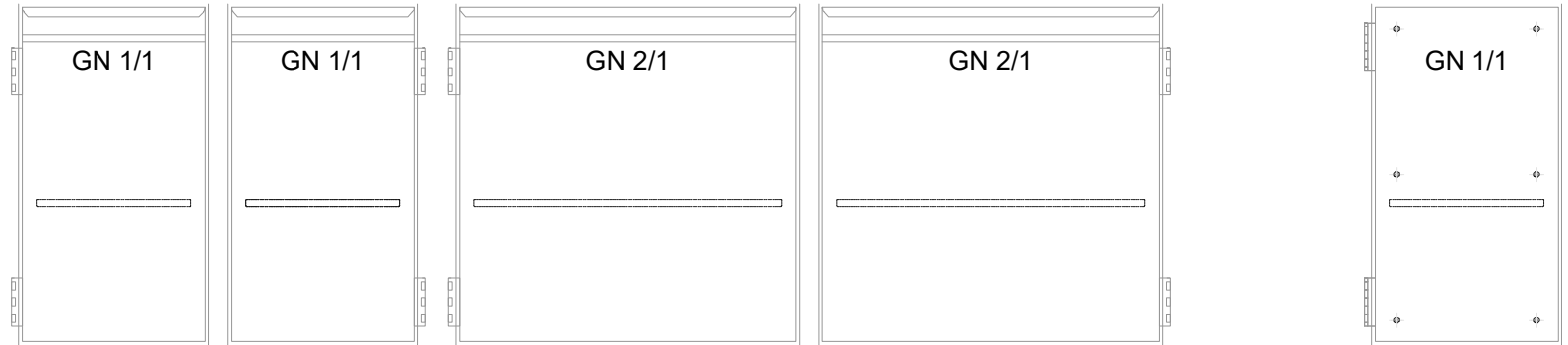
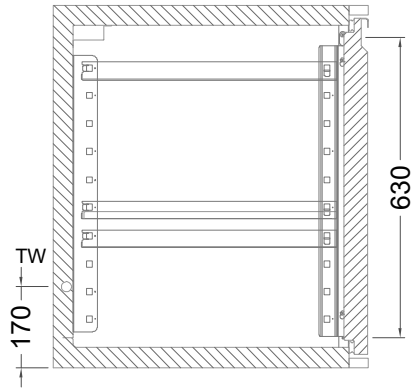

2 Züge 1/2-1/2

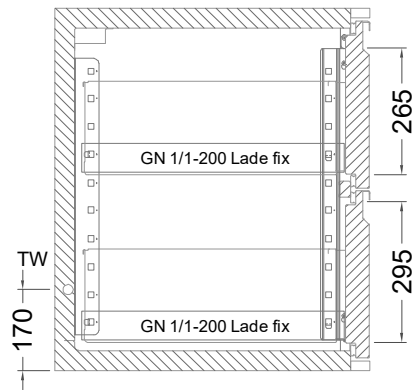

2 Züge FL (Flaschenlade)

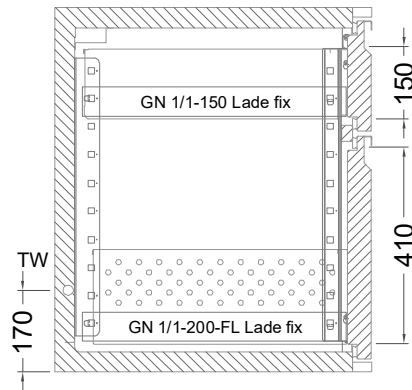

3 Züge 3x1/3

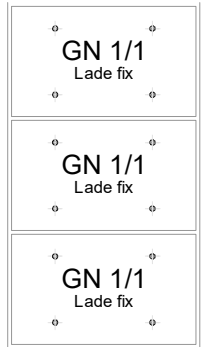
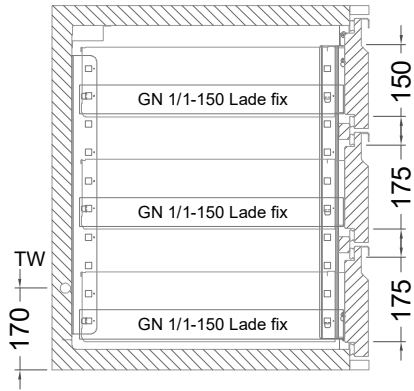

2 Züge 1/2-1/2 mit herausnehmbaren Ladeneinsätzen

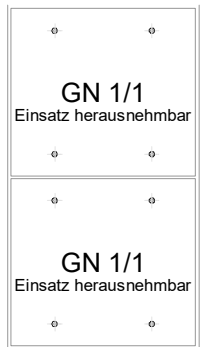
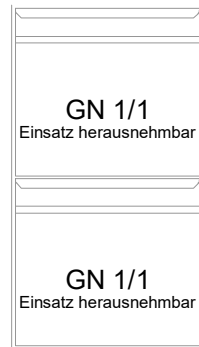
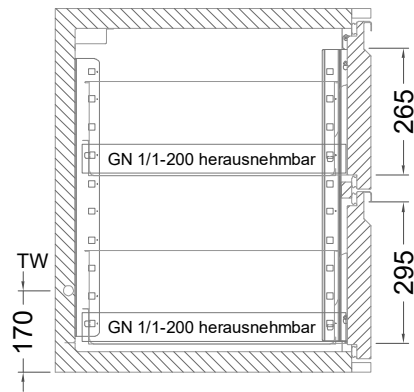

3 Züge 3x1/3 mit herausnehmbaren Ladeneinsätzen

