

Masszeichnung

Wandkühlregal MERCURY 135 H 1424 M1

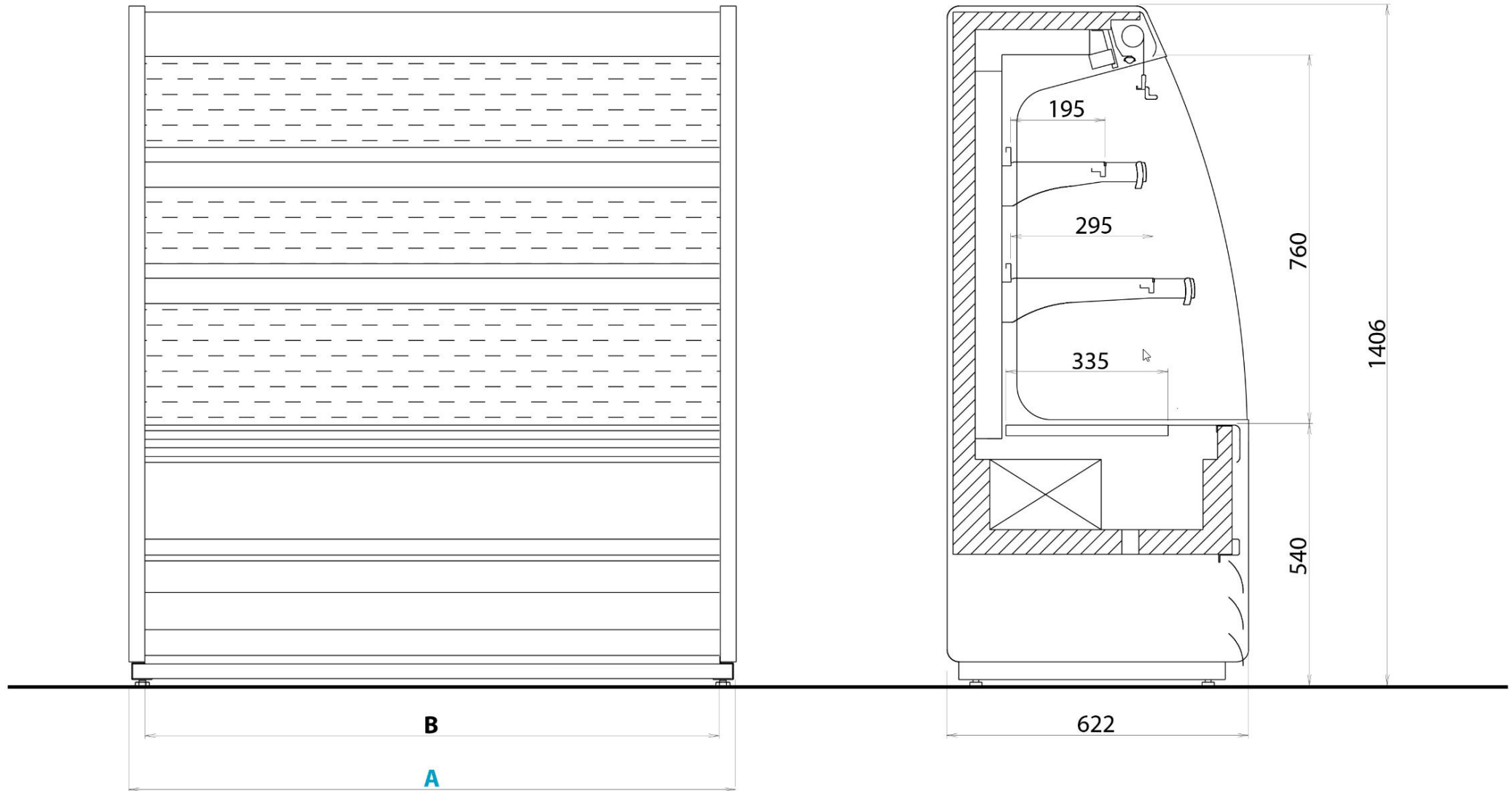

	A	B
71	705	645
100	956	896
135	1340	1290
180	1852	1792

Position Ablauf

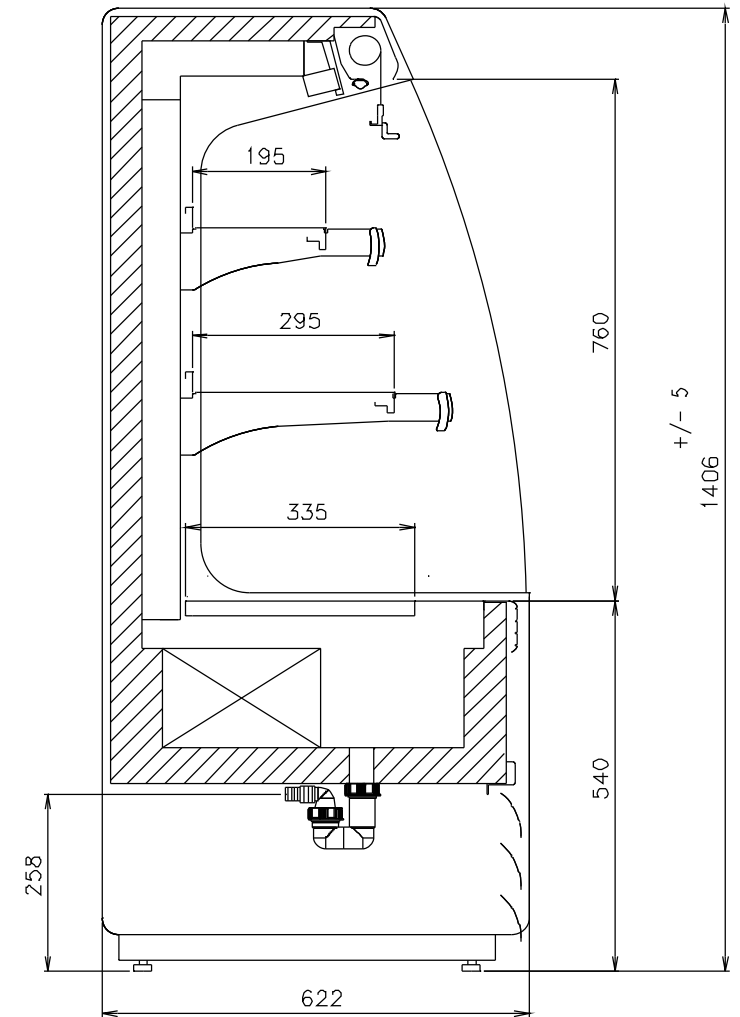
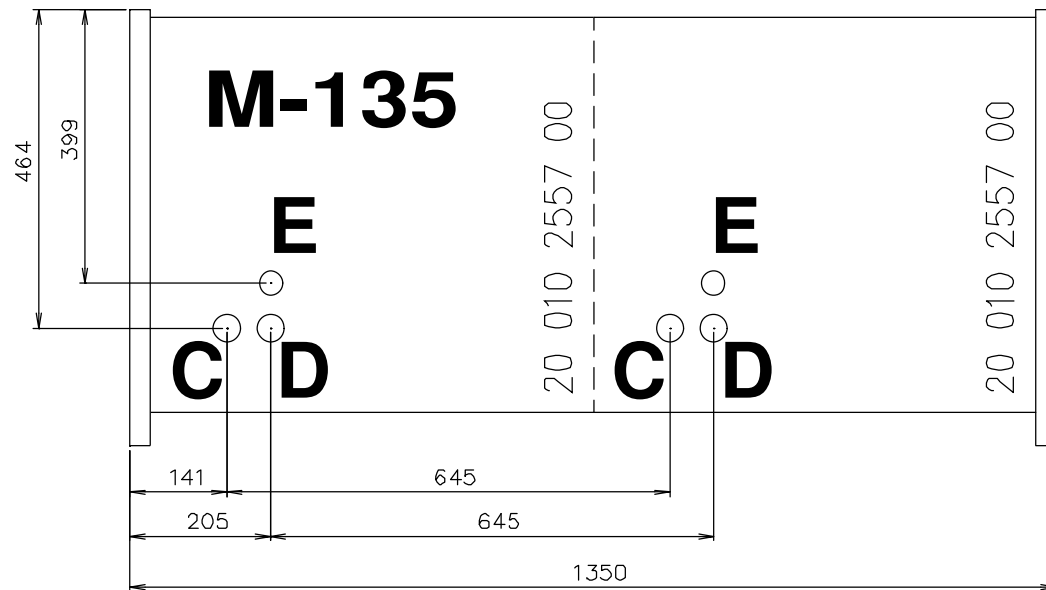

MODELLO	VASCA	FONDO
HFC VBN REMOTE OPEN	20 010 2557 00	60 020 0426 00
HFC VBN REMOTE CLOSED	20 010 2557 00	60 020 0426 00
R290 VBN INTEGRAL OPEN	20 010 2557 00	60 020 0426 00
R290 VBN INTEGRAL CLOSED	20 010 2557 00	60 020 0426 00

C - ELEKTRISCHER KABEL (ELECTRICAL WIRES)
D - ROHRE (PIPES)
E - ABLAUF (DRAIN)