

# Masszeichnung Einbaukühlwanne UKW 4/1-E

[Art. 484253721]

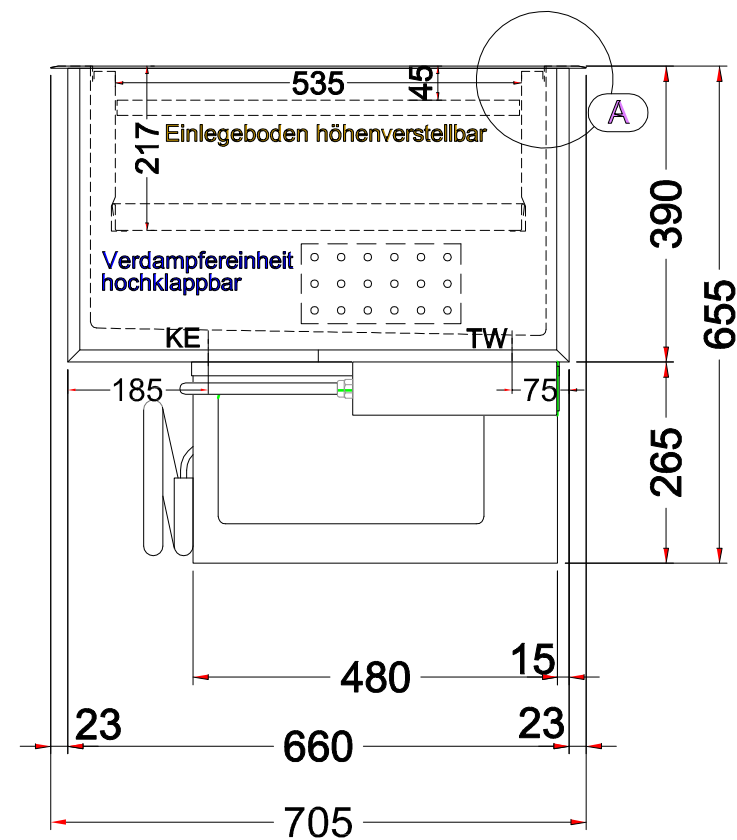

TW = Tauwasserablauf DNØ30  
KE = Kälte-Elektro

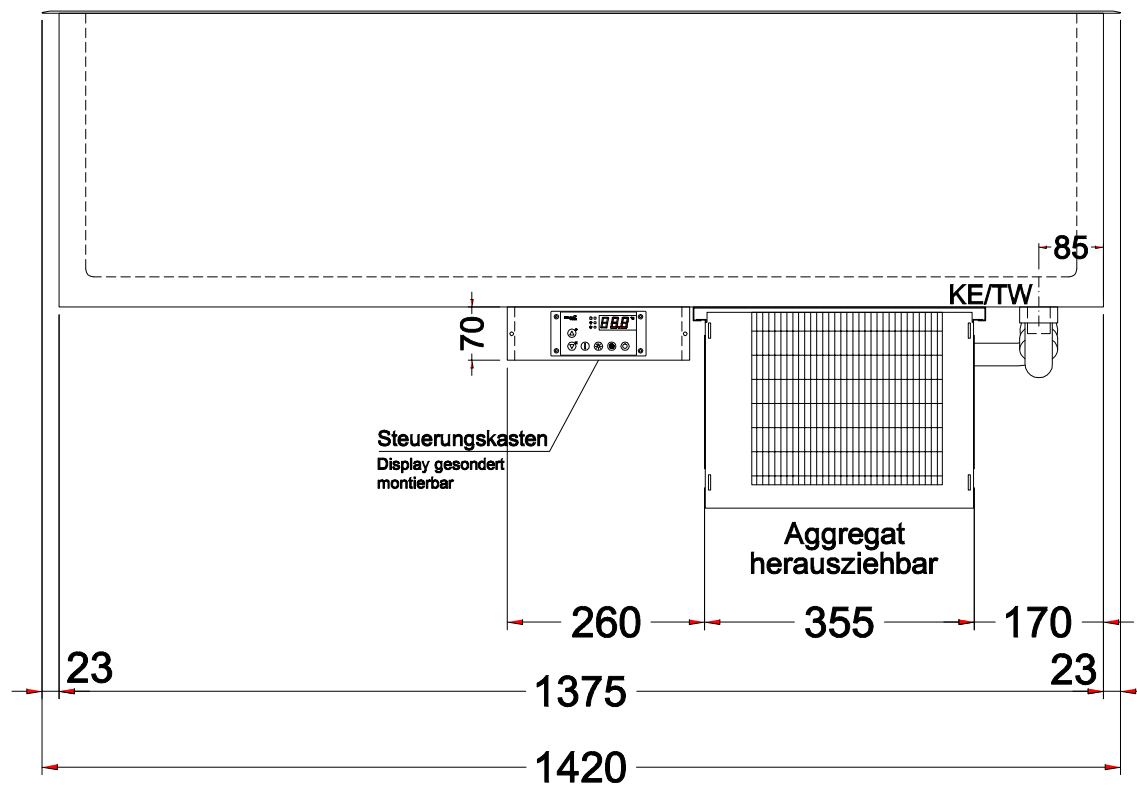
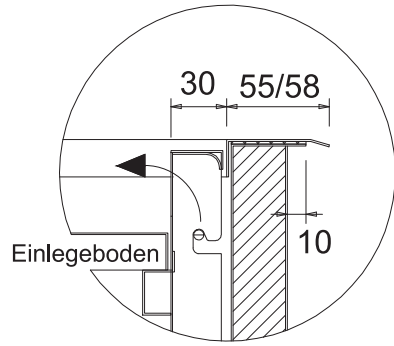

Detail A:

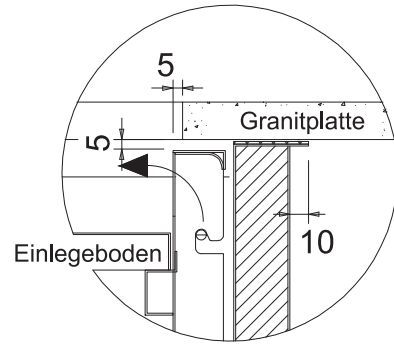

Detail A: Granitunterbau

