

# Ersatzteilliste-Explosionszeichnung

## Elektro-Fritteuse EF7 / 1B15L

[Artikel-Nr.: 406372081]



**FRIGGITRICI ELETTRICHE 15L E700XP**  
**ELECTRIC FRYERS 15L E700XP**

<b>PNC</b>	<b>Model</b>	<b>Ref</b>	<b>Brand</b>	<b>Version</b>	<b>Notes</b>
371081	E7FRED1GF0	a	ELX	EL	15 LITRE 400 MM
371082	E7FREH2GF0	b	ELX	EL	2 X15 LITRE 800 MM
372081	Z7FRED1GF0	c	ZAN	EL	15 LITRE 400 MM
372082	Z7FREH2GF0	d	ZAN	EL	2 X15 LITRE 800 MM
373081	A7FRED1GF0	e	OEM	EL	15 LITRE 400 MM
373082	A7FREH2GF0	f	OEM	EL	2 x15 LITRE 400 MM
373231	A7FRED1GFK	G	KIP	EL	15 LITRE 400 MM

<b>Pag</b>	<b>Index</b>	<b>Indice</b>	<b>Note</b>
2	General components	Componenti struttura	
3	Electric components	Componenti Elettrici	
4,5	Spare parts list	Lista ricambi	

Brand/Marchio: All  
 Factory code: 9PDX

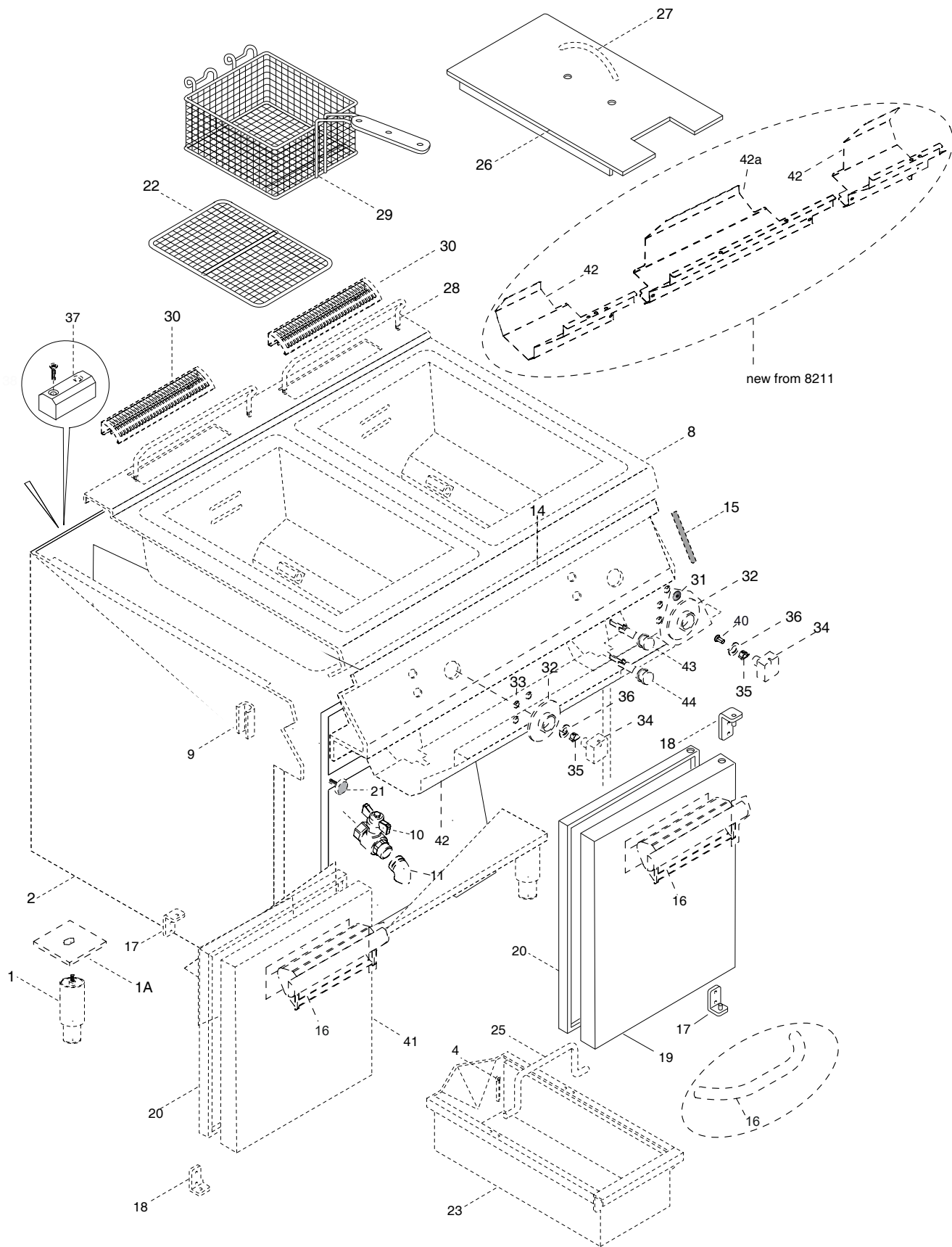

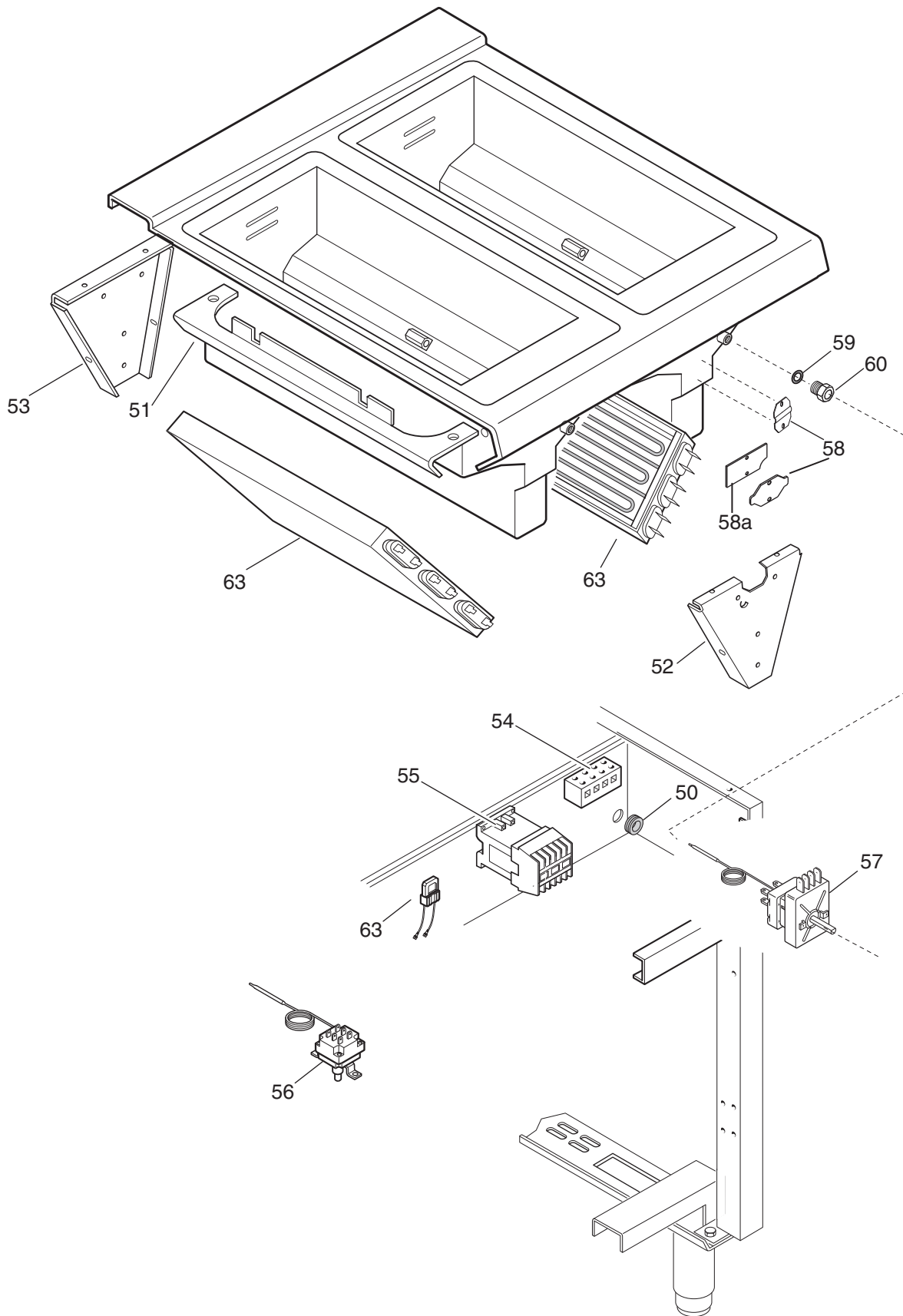

**FRIGGITRICI ELETTRICHE 15L E700XP  
ELECTRIC FRYERS 15L E700XP**

<i>Pos</i>	<i>Factory Code</i>	<i>Spare Part Code</i>	<i>Descrizione</i>	<i>Description</i>	<i>Ref./Note</i>
1	0835856900	0C0204	PIEDE	FOOT	
1A	0508898900	0C0122	PIASTRA DI RINFORZO PER PIEDE	PLATE FOR FOOT	
2	085089FD00	*	RIVESTIMENTO LATERALE 400MM	EXTERNAL PANEL 400MM	ELX
2	085089FH00	*	RIVESTIMENTO LATERALE 400MM	EXTERNAL PANEL 400MM	ZAN, OEM
2	085089FF00	*	RIVESTIMENTO LATERALE 800MM	EXTERNAL PANEL 800MM	ELX
2	085089FJ00	*	RIVESTIMENTO LATERALE 800MM	EXTERNAL PANEL 800MM	ZAN, OEM
4	0219293205	0C0477	COPIGLIA	COTTER	
8	085589BJ02	0C7752	RIPIANO / VASCA 400mm	WORKTOP / TANK 400mm	ELX
8	087089LM02	0C7790	RIPIANO / VASCA 400mm	WORKTOP / TANK 400mm	ZAN, OEM
8	085589BQ02	0C7758	RIPIANO / VASCA 800mm	WORKTOP / TANK 800mm	ELX
8	087089LN02	0C7791	RIPIANO / VASCA 800mm	WORKTOP / TANK 800mm	ZAN, OEM
9	0527850500	0C0156	PIASTRA FISSAGGIO FIANCHI	SIDE PANEL JOINTING PLATE	
10	0835848600	005927	VALVOLA SCARICO	DRAIN VALVE	
<b>11</b>	<b>051489GM00</b>	<b>0CB646</b>	<b>RACCORDO SCARICO</b>	<b>DRAIN CONNECTION</b>	
14	085589AK00	0C7740	CRUSCOTTO 400mm	CONTROL PANEL 400mm	ELX
14	087089J600	0C7517	CRUSCOTTO 400mm	CONTROL PANEL 400mm	ZAN
14	050389N800	0C7523	CRUSCOTTO 400mm	CONTROL PANEL 400mm	OEM
14	085589AL00	0C7741	CRUSCOTTO 800mm	CONTROL PANEL 800mm	ELX
14	087089J100	0C7516	CRUSCOTTO 800mm	CONTROL PANEL 800mm	ZAN
14	050389N900	0C7524	CRUSCOTTO 800mm	CONTROL PANEL 800mm	OEM
15	0543821900	0C2496	GUARNIZIONE X CRUSCOTTO	GASKET, CONTROL PANEL	
16	54887AH00	0C8769	MANIGLIA	HANDLE	ELX
16	54887A802	0C8190	MANIGLIA	HANDLE	ZAN
16	854864203	0A5021	MANIGLIA	HANDLE	OEM
17	0516860801	0C0138	CERNIERA	HINGE, DOOR	
18	0516860901	0C0139	CERNIERA	HINGE, DOOR	
19	050389G300	0C7157	PORTA	DOOR	ELX, ZAN
19	050389MB01	*	PORTA	DOOR	OEM
20	050489CQ00	0C7158	CONTROPORTA	INNER DOOR	
*	085589CT01	0C7163	ASSIEME PORTA	DOOR ASSEMBLY	ELX
*	085589CU05	0C7165	ASSIEME PORTA	DOOR ASSEMBLY	ZAN
*	085589CV00	0C7627	ASSIEME PORTA	DOOR ASSEMBLY	OEM
21	0830898200	0C0201	MAGNETE PER PORTA	MAGNET, DOOR	
22	0830822500	005932	GRIGLIA DI FONDO	GRATE FOR BOTTOM	
23	0502898403	005922	BACINELLA PER OLIO	BASIN FOR BASIN	
25	0516843003	005923	MANIGLIA	LEFT HANDLE	
26	0522893500	0C2697	COPERCHIO	LID	
27	0511819000	0C0614	MANIGLIA COPERCHIO	HANDLE, LID	
28	0516862900	0C0640	SUPPORTO PER CESTELLO	SUPPORT; BASKET	Up to 6221
28	0516862901	0CA773	SUPPORTO PER CESTELLO	SUPPORT; BASKET	From 6231
29	0830822603	005933	CESTELLO	BASKET	
30	050389LP00	0C7333	GRIGLIA CAMINO	GRID, LITTLE CHIMNEY	
31	0541813800	0C6171	MOLLA PER MARCHIO	SPRING, BRAND	
32	0548877L00	0C7481	GHIERA	RING, KNOB	ELX
32	0548879W00	0C7485	GHIERA	RING, KNOB	ZAN, OEM
33	0218912211	069567	MOLLA PER GHIERA	SPRING, RING KNOB	
34	0511850G01	0C6670	MANOPOLA	KNOB	ELX
34	0548878201	0C7232	MANOPOLA	KNOB	ZAN, OEM
34	0548876X00	0C6747	MANOPOLA	KNOB	KIP
35	0214590701	025245	MOLLETTA PER MANOPOLA	SPRING, KNOB	
36	0543821000	053816	GUARNIZIONE PER MANOPOLA	GASKET, KNOB	
37	0516860700	0C0137	PIASTRA GIUNZIONE APPARECC.	JOINTING REAR PLATE	
40	0548877V00	0C7345	ADATTATORE MANOPOLA	KNOB, ADAPTER	ELX
41					
42	0522893004	0C2695	PANNELLO FRONTALE 400MM	FRONTAL PANEL 400MM	400mm – Up to 8201
42	0522893100	0C2696	PANNELLO FRONTALE 800MM	FRONTAL PANEL 800MM	800mm – Up to 8201
42	0522893005	0C2695	PANNELLO FRONTALE 400MM	FRONTAL PANEL 400MM	400mm/800mm – From 8211

**FRIGGITRICI ELETTRICHE 15L E700XP  
ELECTRIC FRYERS 15L E700XP**

<i>Pos</i>	<i>Factory Code</i>	<i>Spare Part Code</i>	<i>Descrizione</i>	<i>Description</i>	<i>Ref./Note</i>
42a	050489XV00	*	PANNELLO FRONTALE 800MM	FRONTAL PANEL 800MM	800mm – From 8211
43	0876800002	005010	LAMPADA SPIA VERDE	GREEN LAMP	
44	0876800102	005011	LAMPADA SPIA GIALLA	YELLOW LAMP	
50	0246530100	005382	PASSACAVO	GROMMET	
51	0528850400	*	FISSAGGIO SUPERIORE RESISTENZE	TOP FIXING PLATE HEAT.ELEMENT	
52	0533824600	0C2713	SUPPORTO ANT.RESISTENZA	FRONTAL SUPPORT, HEAT.ELEMENT	Up to 7291
52	0533824601	0CB178	SUPPORTO ANT.RESISTENZA	FRONTAL SUPPORT, HEAT.ELEMENT	From 7301
53	0533824700	0C2949	SUPPORTO POST.RESISTENZA	REAR SUPPORT, HEAT.ELEMENT	Up to 7291
53	0533824701	0CB176	SUPPORTO POST.RESISTENZA	REAR SUPPORT, HEAT.ELEMENT	From 7301
54	0A05714000	058613	MORSETTIERA	TERMINAL BOARD	
55	0648807400	006879	CONTATTORE	CONTACTOR	
<b>56</b>	<b>0646816601</b>	<b>0C4463</b>	<b>LIMITATORE DI TEMPERATURA</b>	<b>SAFETY THERMOSTAT</b>	
57	0446578713	052330	INTERRUTTORE CON THERMOSTATO	SWITCH WITH THERMOSTAT	
58	0527871901	0C4749	SQUADRETTA SUPPORTO BULBO	PLATE FOR BULB	
58a	0569806300	0C4748	ISOLANTE BULBO	BULB INSULATION	
59	0543815000	059293	GUARNIZIONE PER BULBO	GASKET, BULBO THERMOSTAT	
60	0514874500	059295	RACCORDO PER BULBO	PIPE FITTING, BULB THERMOSTAT	
63	0617821403	005942	RESISTENZA; 5000 W-230V	HEATING ELEMENT; 5000 W-230V	
*	*	0CB471	KIT MANUTENZIONE FRIGGITRICI ELETTRICHE 15/23LT E700/E900	E700/E900 15/23LT ELECTRIC FRYER MAINTENANCE KIT	15LT (15+43+59+60)
*	*	0CB472	KIT MANUTENZIONE FRIGGITRICI ELETTRICHE 2x15/23LT E700/E900	E700/E900 2x15/23LT ELECTRIC FRYER MAINTENANCE KIT	2x15LT 15+2x43+2x59+2x60)

**Finanzen/Service**

**28307 Bremen**  
Thalendorststraße 15  
Tel.+49 421 48557-0  
Fax+49 421 488650  
bremen@nordcap.de

**Vertrieb Ost**

**12681 Berlin**  
Wolfener Straße 32/34, HausK  
Tel.+49 30 936684-0  
Fax+49 30 936684-44  
berlin@nordcap.de

**Vertrieb West**

**40699 Erkrath**  
Max-Planck-Straße 30  
Tel.+49 211 540054-0  
Fax+49 211 540054-54  
erkrath@nordcap.de

**Vertrieb Nord**

**21079 Hamburg**  
Großmoorbogen 5  
Tel.+49 40 766183-0  
Fax+49 40 770799  
hamburg@nordcap.de

**Vertrieb Süd**

**55218 Ingelheim**  
Hermann-Bopp-Straße 4  
Tel.+49 6132 7101-0  
Fax+49 6132 7101-20  
ingelheim@nordcap.de



[www.nordcap.de](http://www.nordcap.de)