

Ersatzteilliste-Explosionszeichnung

Glastürkühlschrank M 150

[Artikel-Nr.: 477850150]

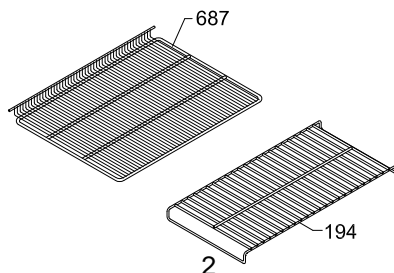

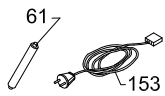
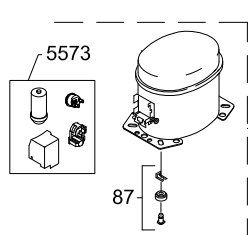
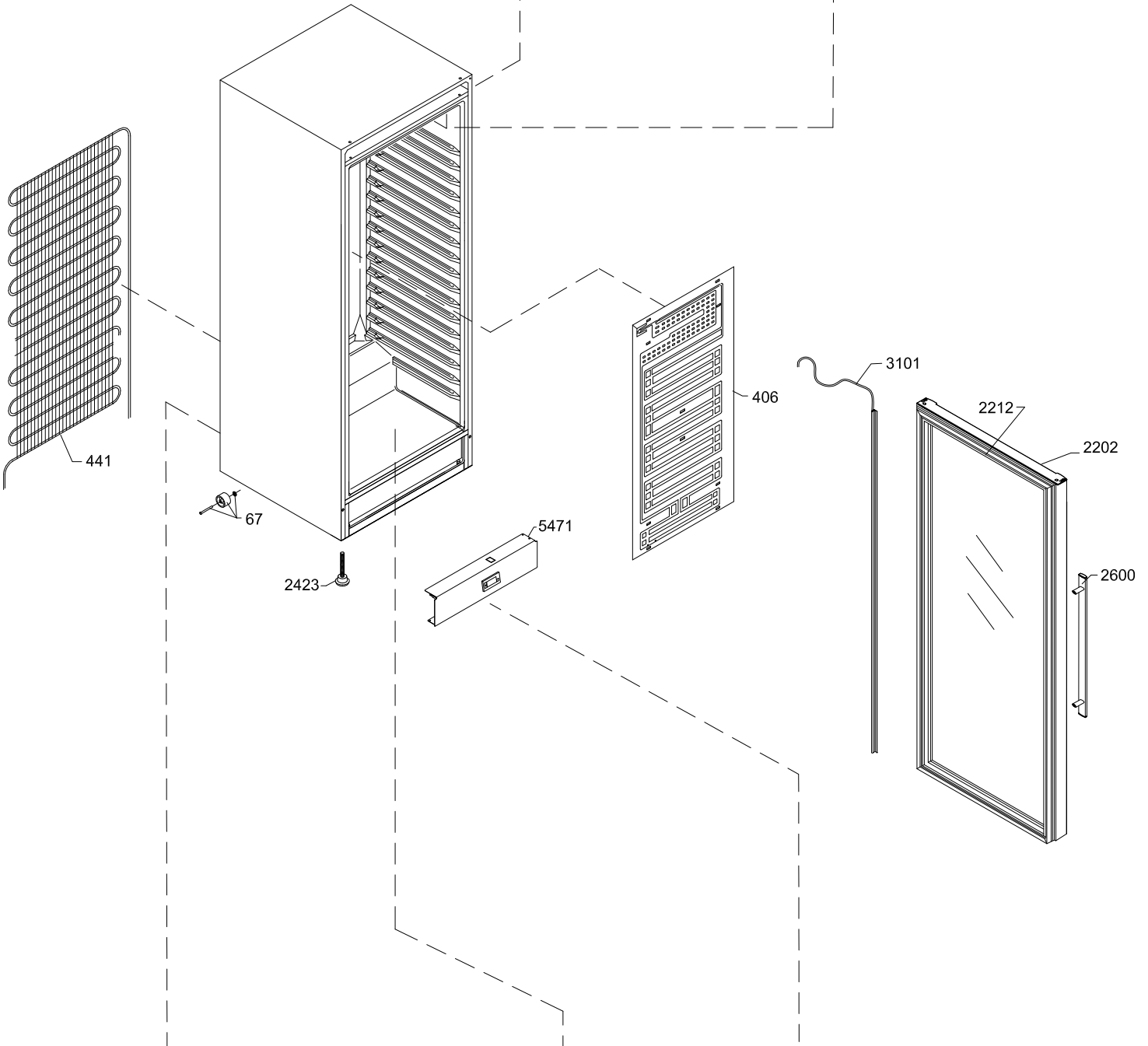
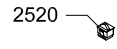
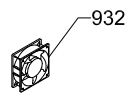
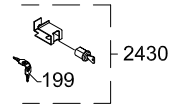

2

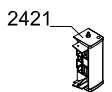
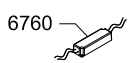
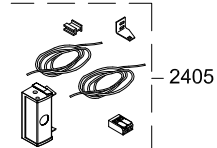

Position	Item number	Item name
0061	0-6538001	Filter drier,
0067	0-5235002	Castor, complete
0087	0-6038175	Base plate fittings, complete
0129	8-036510839	Compressor - Complete EMX3118Y
0153	7535380	Power cord
0194	0-6938086	Wire shelf
0199	0-4838236	Key, set - 2
0406	6020273-01	Evaporator
0441	0-6238301	Condenser
0687	0-6938167	Wire shelf
0702	0-8550066-03	Hinge, right
0709	0-52387110103	Bush
0932	7030325	Ventilator FAN3483, KF1225B1LR-R with Tyco-MNL / Ventilátor
1022	3010824	Defrost water hose
1209	6520430	Evaporating tray
2202	0-028001401	Door, complete
2212	3020675-03	Gasket
2405	A1025359	Service kit - Door Reversing
2420	A102530217	"L" Hinge + covering
2421	A102530218	"R" Hinge + covering + tap
2423	0-20381290103	Ajustable foot
2430	0-A9151272	Lock complete
2520	0-70387190103	Switch for light
2600	0-A90135301	Hand lever
2655	0-A910112	Contact face for hinge, right, complete
2656	0-A910133	Contact face for hinge, left complete
3101	7010213	LED light - door
5471	7095142	Bottom panel, complet
5472	7020371	HSU NTC-Sensor Kit
5473	7020370	NTC-Sensor Kit
5573	A921321	Electrical parts for compressor
5712	7095151	Electronic controller ERC 112C
6760	7020367	Transformer
6761	7020368	Transformer
XXXX	1006372	Wire diagram

Subject to changes without prior notice.

Position	Varenummer	Varenavn
0061	0-6538001	Tørrefilter,
0067	0-5235002	Hjul - komplet
0087	0-6038175	Fodpladetilbehør, komplet
0129	8-036510839	Kompressor - komplet - EMX3118Y
0153	7535380	Netledning
0194	0-6938086	Trådhylde , bund
0199	0-4838236	Nøgle. sæt - 2 stk.
0406	6020273-01	Roll Bond Fordamper
0441	0-6238301	Kondensator
0687	0-6938167	Trådhylde
0702	0-8550066-03	Tophængsel
0709	0-52387110103	Bøsning
0932	7030325	Ventilator
1022	3010824	Tøvandsslange
1209	6520430	fordamperskål
2202	0-028001401	Dør, komplet
2212	3020675-03	Tætningsliste
2405	A1025359	Service kit - Dørvending
2420	A102530217	"L" Hængsel + Afdækning
2421	A102530218	"R" Hængsel + afdækning + tap
2423	0-20381290103	Stilbare fod
2430	0-A9151272	Lås komplet
2520	0-70387190103	Kontakt for lys
2600	0-A90135301	Håndtag
2655	0-A910112	Anlæg for hængsel, højre, samlet
2656	0-A910133	Anlæg for hængsel, venstre, samlet
3101	7010213	LED lys - dør
5471	7095142	Bundpanel, fodspark - komplet
5472	7020371	HSU NTC-Sensor Kit
5473	7020370	NTC-Sensor Kit
5573	A921321	EI dele til kompressor
5712	7095151	Electronic controller ERC 112C
6760	7020367	Transformer
6761	7020368	Transformer
XXXX	1006372	Wire diagram

Ret til ændringer uden varsel forbeholdes.

Position	Artikelnummer	Artikelname
0061	0-6538001	Trockner,
0067	0-5235002	Rad , komplett
0087	0-6038175	Fussplattenzubehör,, komplett
0129	8-036510839	Kompressor - EMX3118Y
0153	7535380	Netzanschlussleitung
0194	0-6938086	Drahtregal
0199	0-4838236	Schlüssel, Satz - 2 Stück
0406	6020273-01	Verdampfer
0441	0-6238301	Kondensator
0687	0-6938167	Drahtabstellplatte
0702	0-8550066-03	Scharnier, rechts
0709	0-52387110103	Buchse
0932	7030325	Ventilator
1022	3010824	Tauwasserschlauch
1209	6520430	Verdampfungsschale
2202	0-028001401	Tür, komplett
2212	3020675-03	Dichtungsleiste
2405	A1025359	Service-Kit - Tür Umschlagen
2420	A102530217	"L" Scharnier + Abdeckung
2421	A102530218	"R" Scharnier + Abdeckung + tap
2423	0-20381290103	Fußschraube
2430	0-A9151272	Schloss komplett
2520	0-70387190103	Schalter für Licht
2600	0-A90135301	Handgriff
2655	0-A910112	Anschlagflèche für Scharnier, rechts, komplett
2656	0-A910133	Anschlagflèche für Scharnier, links, komplett
3101	7010213	LED light - tür
5471	7095142	Bodenpaneel, Fussleiste - komplett
5472	7020371	HSU NTC-Sensor Kit
5473	7020370	NTC-Sensor Kit
5573	A921321	Elektrische Teile für Kompressor
5712	7095151	Elektronische Einheit ERC 112C
6760	7020367	Transformator
6761	7020368	Transformator
XXXX	1006372	Wire diagram

Änderungen ohne Mitteilung vorbehalten.

Finanzen/Service

28307 Bremen
Thalenhorststraße 15
Tel.+49 421 48557-0
Fax+49 421 488650
bremen@nordcap.de

Vertrieb Ost

12681 Berlin
Wolfener Straße 32/34, Haus K
Tel.+49 30 936684-0
Fax+49 30 936684-44
berlin@nordcap.de

Vertrieb West

40699 Erkrath
Max-Planck-Straße 30
Tel.+49 211 540054-0
Fax+49 211 540054-54
erkrath@nordcap.de

Vertrieb Nord

21079 Hamburg
Großmoorbogen 5
Tel.+49 40 766183-0
Fax+49 40 770799
hamburg@nordcap.de

Vertrieb Süd

55218 Ingelheim
Hermann-Bopp-Straße 4
Tel.+49 6132 7101-0
Fax+49 6132 7101-20
ingelheim@nordcap.de

