

# Masszeichnung

## Einbaukühlwanne UKW Vario Lift 2-1-E R290



NordCap®

CONCEPT-LINE

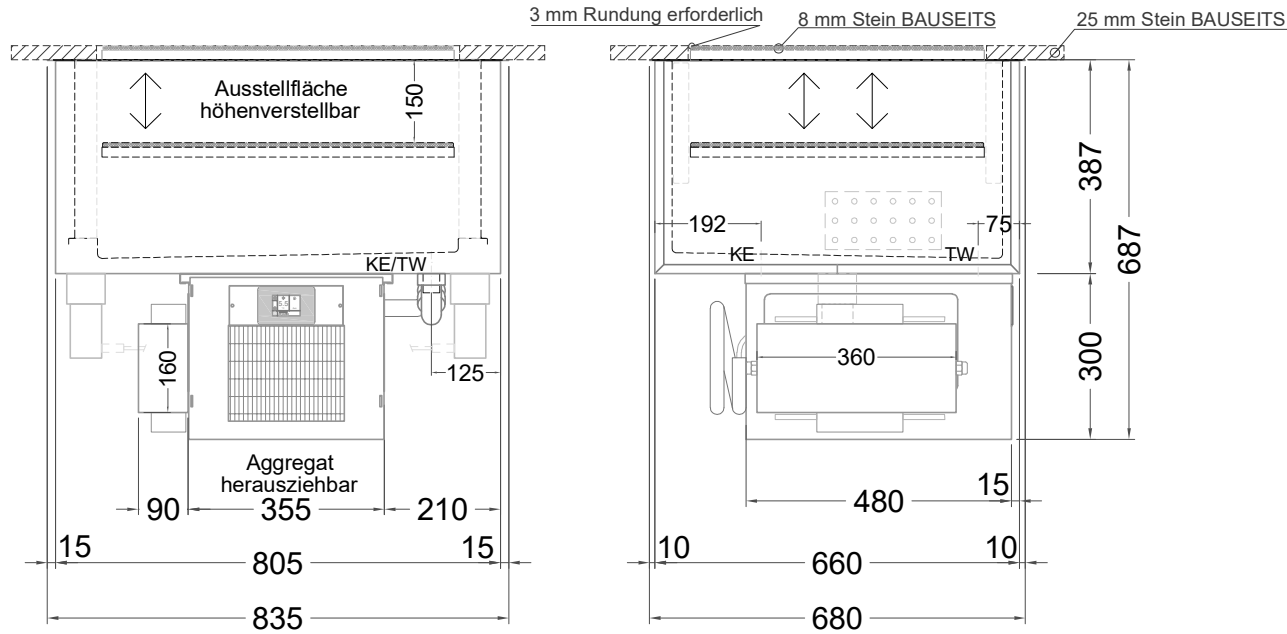

TW = Tauwasserablauf DNØ30  
KE = Kälte-Elektro

[Art.Nr.: 358870]

**UKW Vario Lift 2-1-E R290**

