

Masszeichnung

Kühltisch (3 Abteile) KTE 3-65-3T MFL (R-290)

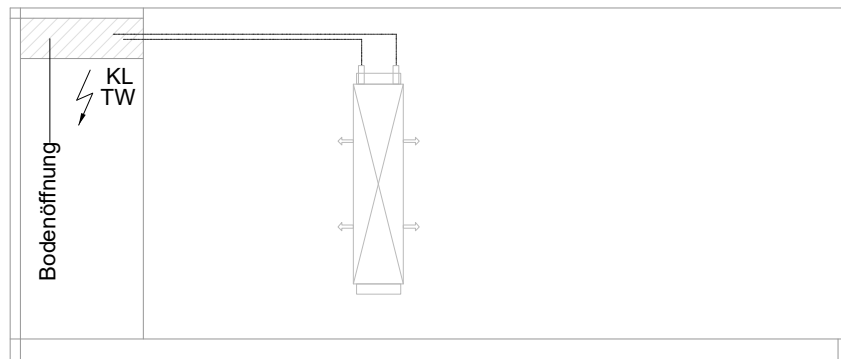
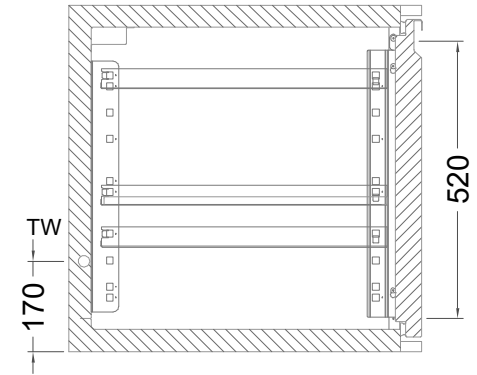
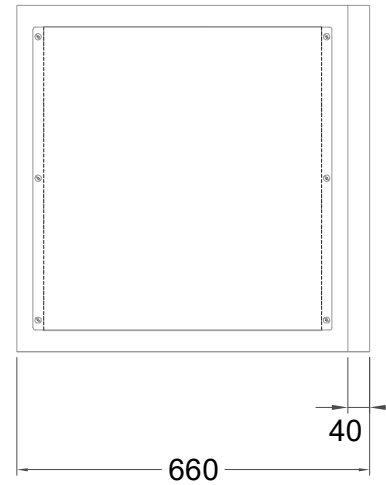
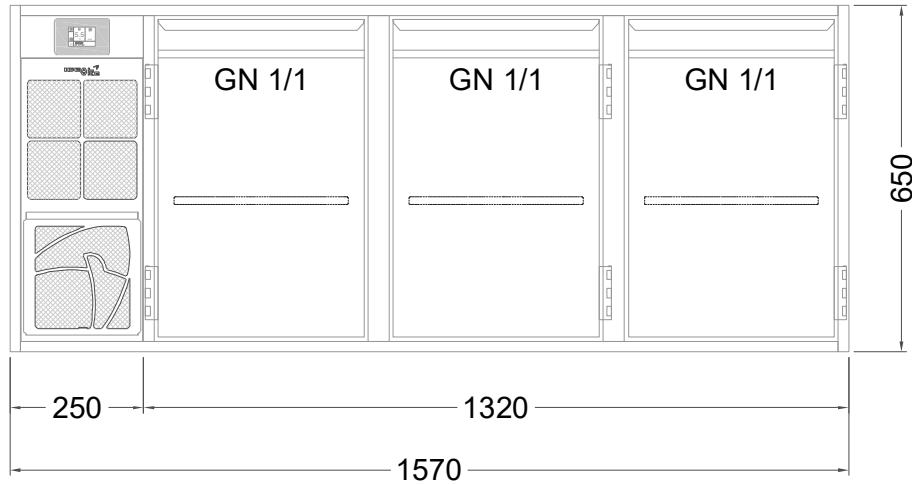

[Art.Nr.: 31000587]

KTE 3-65-3T

- * KL...Kälteleitungen
- * TW...Tauwasser - kein bauseitiger Ablauf erforderlich

Türelement

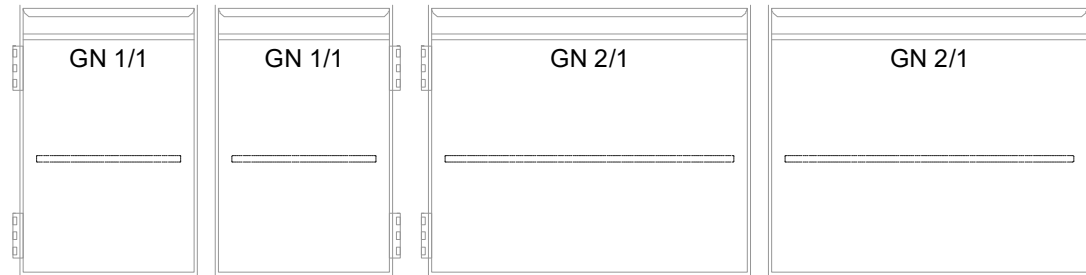
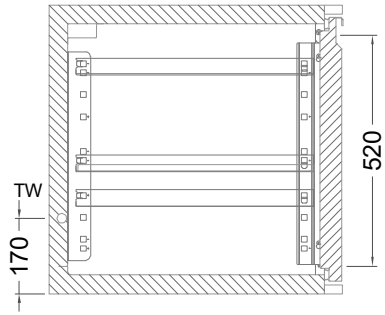

2 Züge 1/2-1/2

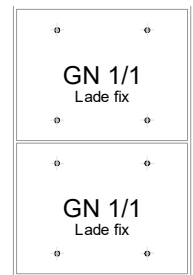
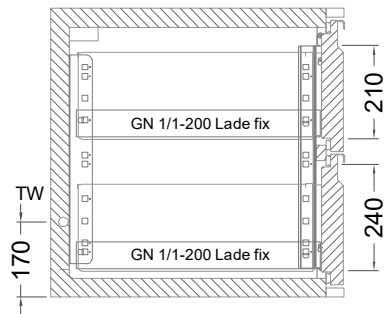

2 Züge FL (Flaschenlade)

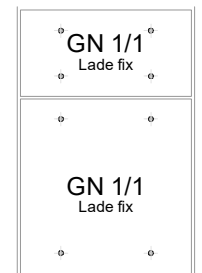
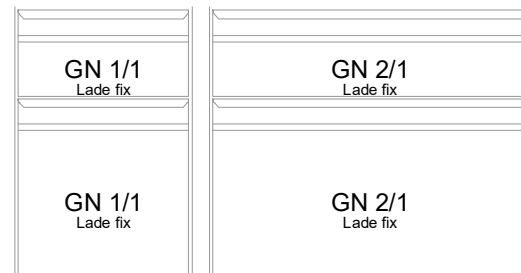
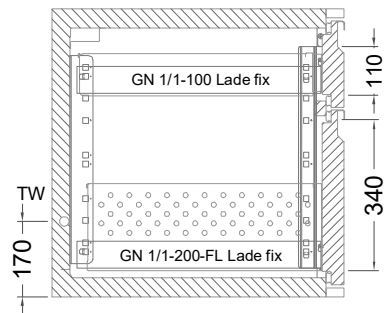

3 Züge 3x1/3

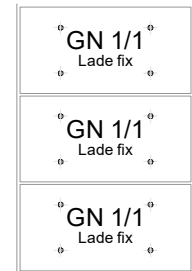
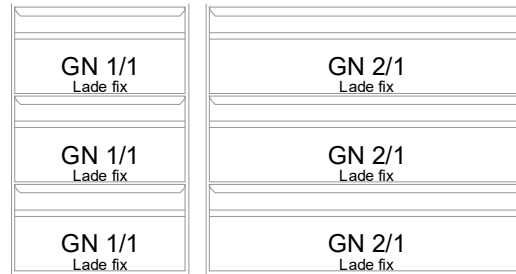
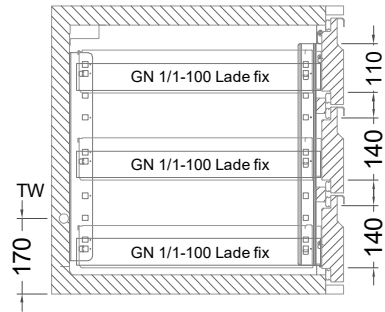

2 Züge 1/2-1/2 mit herausnehmbaren Ladeneinsätzen

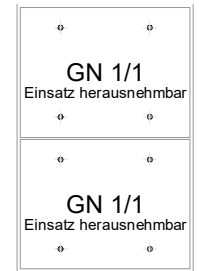
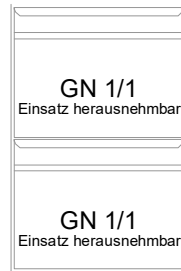
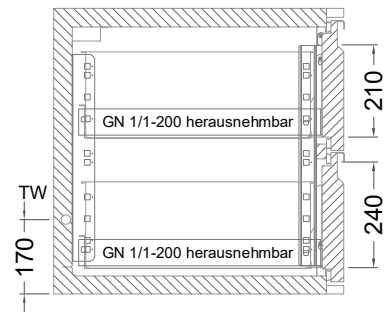

3 Züge 3x1/3 mit herausnehmbaren Ladeneinsätzen

