

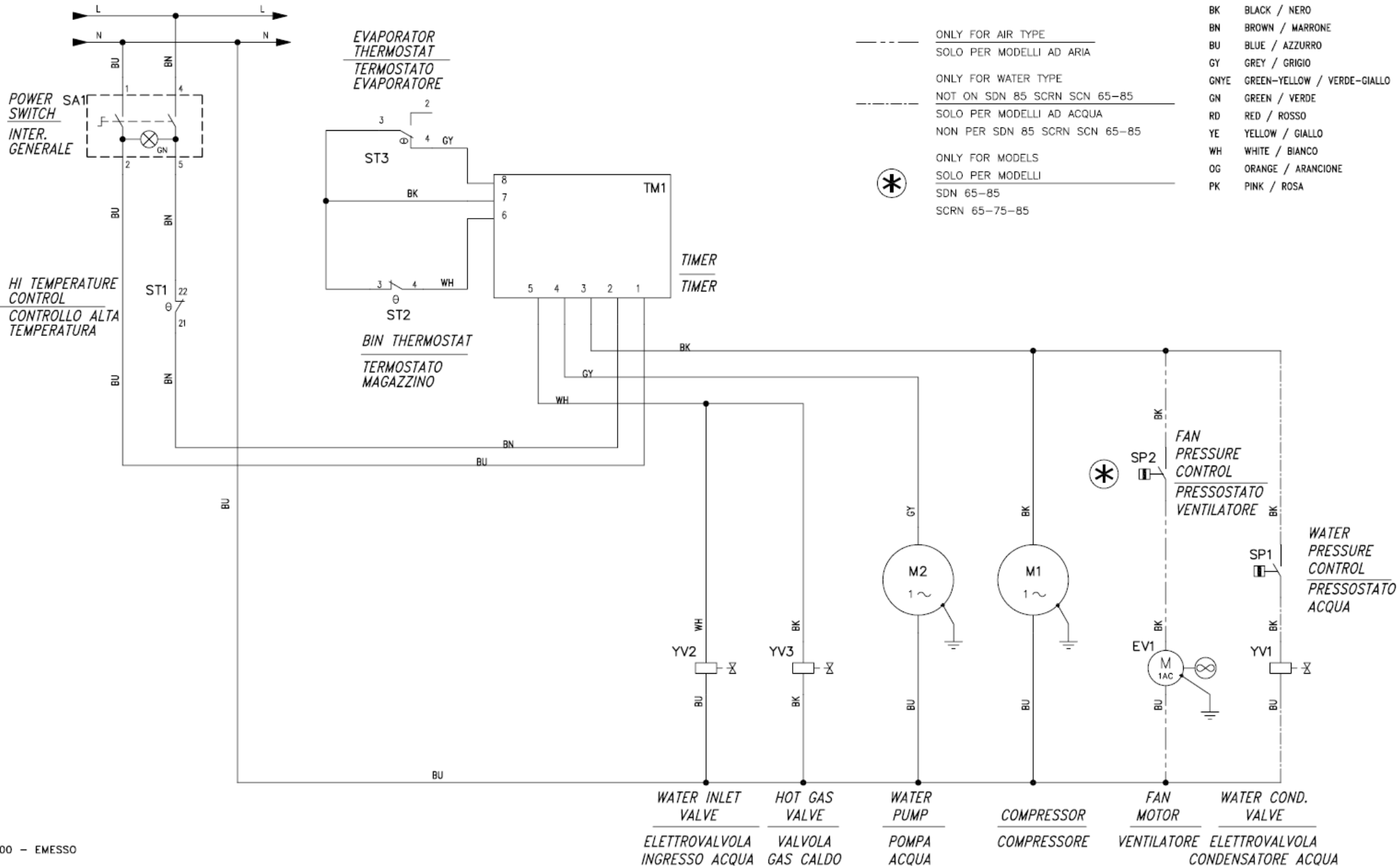















Schaltplan

Eiswürfelbereiter SDE 30 W





| Sim.\Sym. | Sigla\Item | Funzione\Use Type |
|---|------------|--|
|  | EV1 | Fan motor Ventilatore |
|  | M1 | Compressor Compressore |
|  | M2 | Water pump Pompa acqua |
|  | M3 | Pump water discharge Pompa scarico acqua |
|  | SA2 | Power switch Interruttore generale |
|  | SK1 | PWC control board Scheda controllo PWC |
|  | SP1 | Pressure water control Pressostato acqua |
|  | SP2 | Fan pressure control Pressostato ventilatore |
|  | ST1 | HI Temperature control Controllo alta temperatura |
|  | ST2 | Bin thermostat Termostato magazzino |
|  | ST3 | Evaporator thermostat Termostato evaporatore |

| Sim.\Sym. | Sigla\Item | Funzione\Use Type |
|--|------------|--|
|  | TM1 | Electronic timer Timer elettronico |
|  | WS1 | Water level sensor Sensore livello acqua |
|  | YV1 | Water condenser valve Elettrovalvola condensatore acqua |
|  | YV2 | Water inlet valve Elettrovalvola ingresso acqua |
|  | YV3 | Hot gas valve Elettrovalvola gas caldo |
| | | |
| | | |
| | | |
| | | |
| | | |
| | | |
| | | |

BK **BLACK**
BN **BROWN**
BU **BLUE**
GY **GREY**
GNYE **GREEN-YELLOW**
GN **GREEN**
RD **RED**
YE **YELLOW**
WH **WHITE**
OG **ORANGE**
PK **PINK**

Finanzen/Service
28307 Bremen
Thalenhorststraße 15
Tel.+49 421 48557-0
Fax+49 421 488650
bremen@nordcap.de

Vertrieb Ost
12681 Berlin
Wolfener Straße 32/34, Haus K
Tel.+49 30 936684-0
Fax+49 30 936684-44
berlin@nordcap.de

Vertrieb West
40699 Erkrath
Max-Planck-Straße 30
Tel.+49 211 540054-0
Fax+49 211 540054-54
erkrath@nordcap.de

Vertrieb Nord
21079 Hamburg
Großmoorbogen 5
Tel.+49 40 766183-0
Fax+49 40 770799
hamburg@nordcap.de

Vertrieb Süd
55218 Ingelheim
Hermann-Bopp-Straße 4
Tel.+49 6132 7101-0
Fax+49 6132 7101-20
ingelheim@nordcap.de



www.nordcap.de