

Masszeichnung

Kühltisch (1 Abteil) KTE 1-71-1T MFR (R-290)

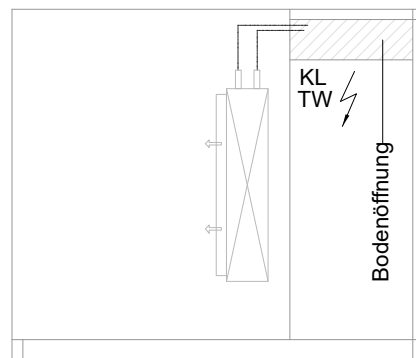
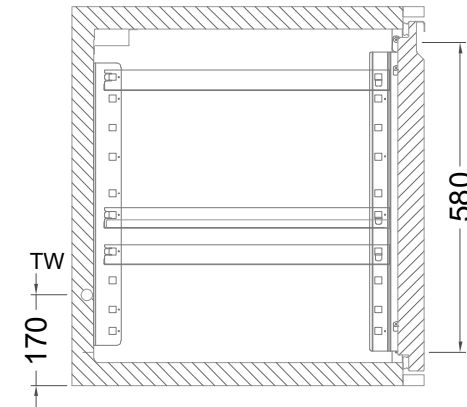
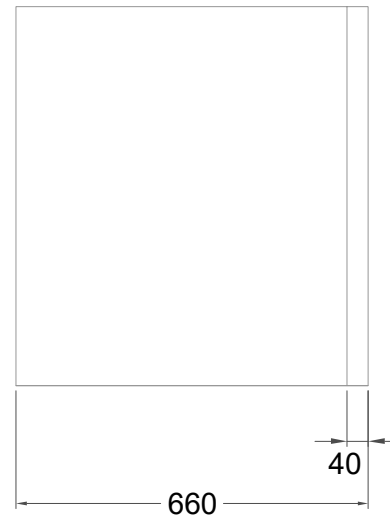
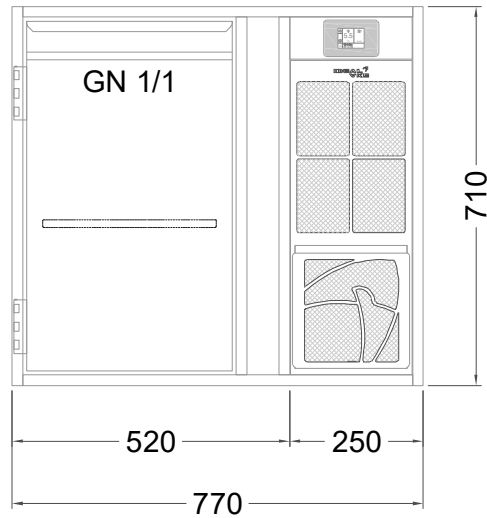

[Art.Nr.: 31000562]

KTE 1-71-1T

- * KL...Kälteleitungen
- * TW...Tauwasser - kein bauseitiger Ablauf erforderlich

Türelement

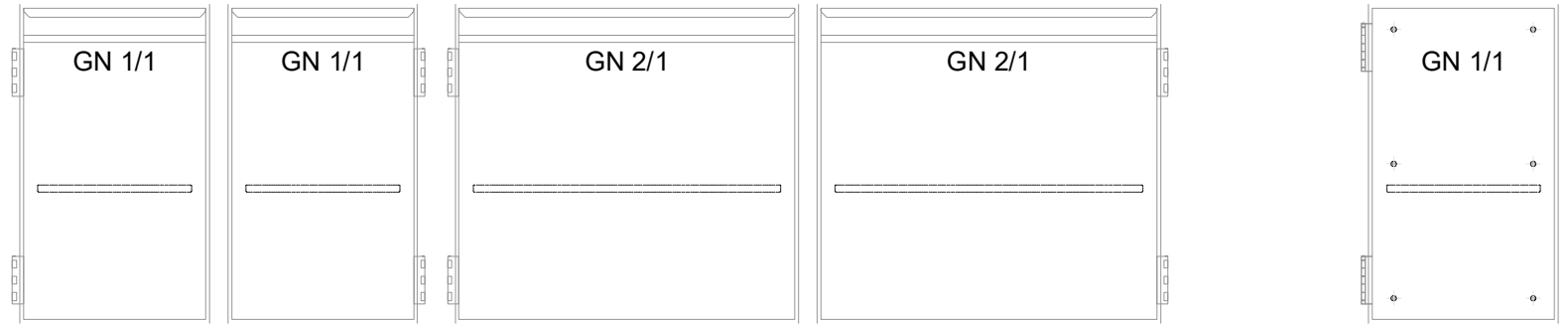
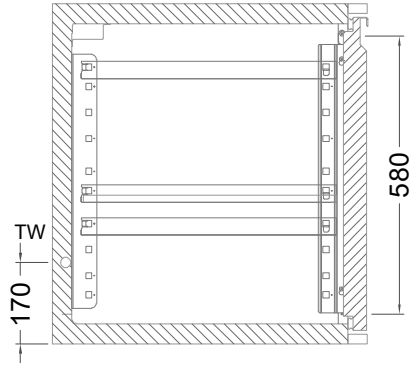

2 Züge 1/2-1/2

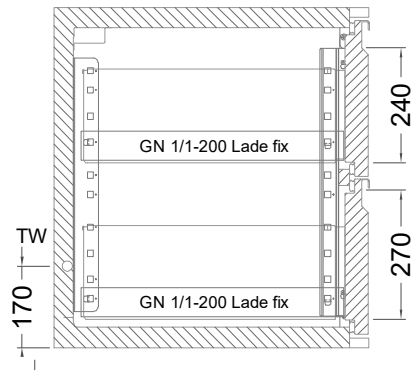

2 Züge FL (Flaschenlade)

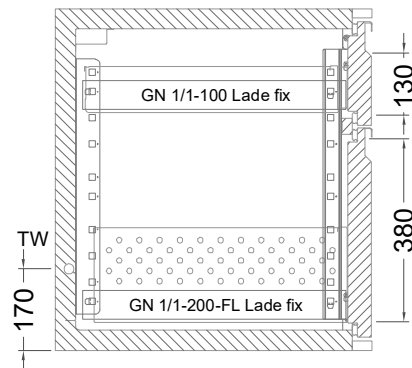

3 Züge 3x1/3

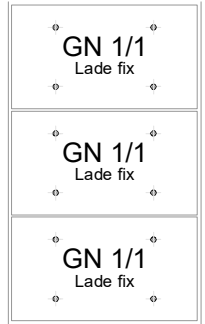
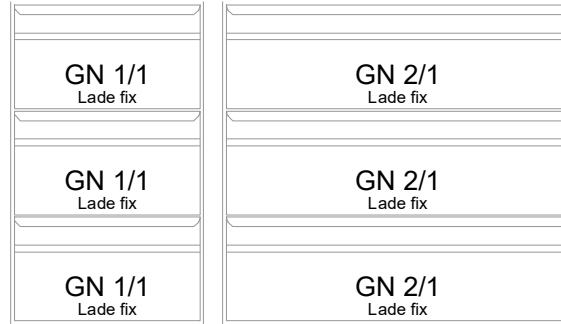
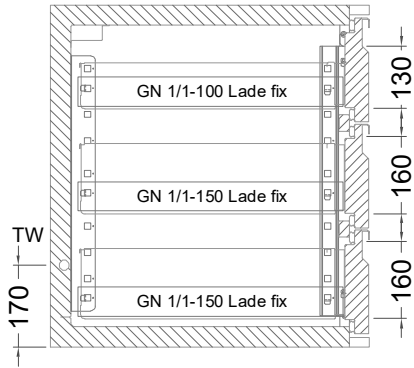

2 Züge 1/2-1/2 mit herausnehmbaren Ladeneinsätzen

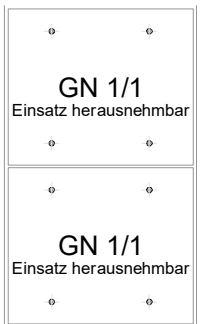
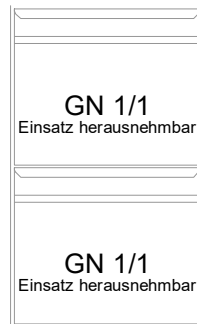
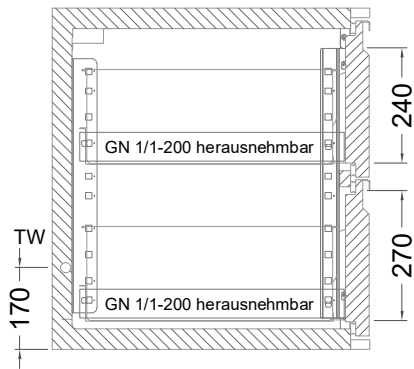

3 Züge 3x1/3 mit herausnehmbaren Ladeneinsätzen

