

Masszeichnung Salatbar TR-GREEN 3/1

[Art. 434700501]

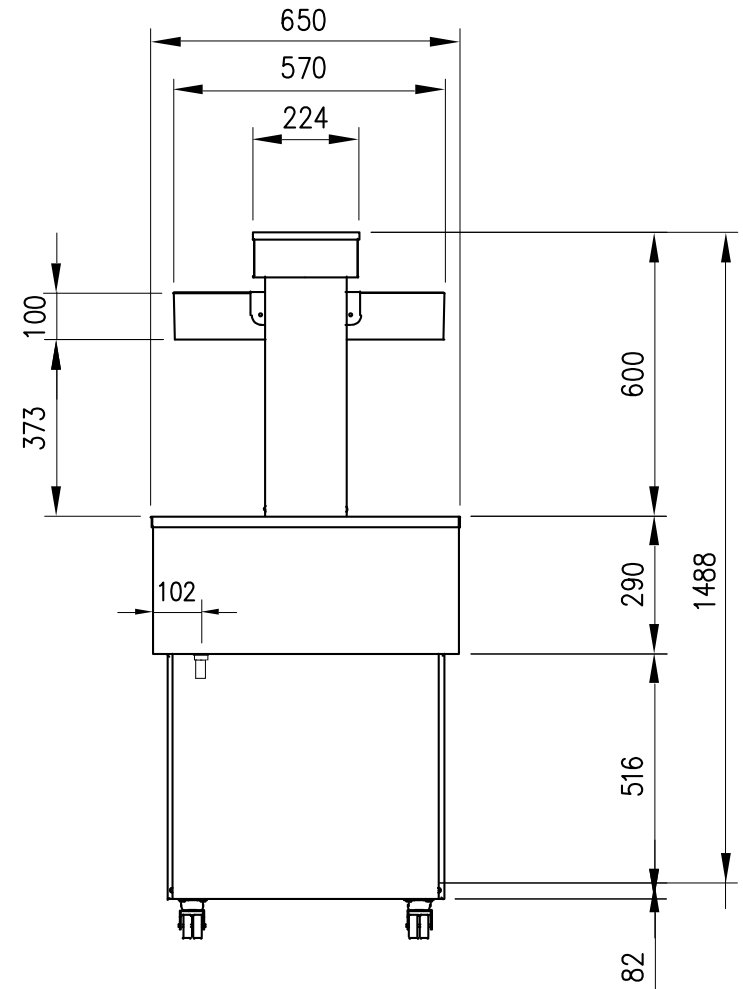

A= ELECTRICAL CONNECTION
D= WATER DISCHARGE $\varnothing 14$
E= GAS CONNECTION $\varnothing 6 \varnothing 8$

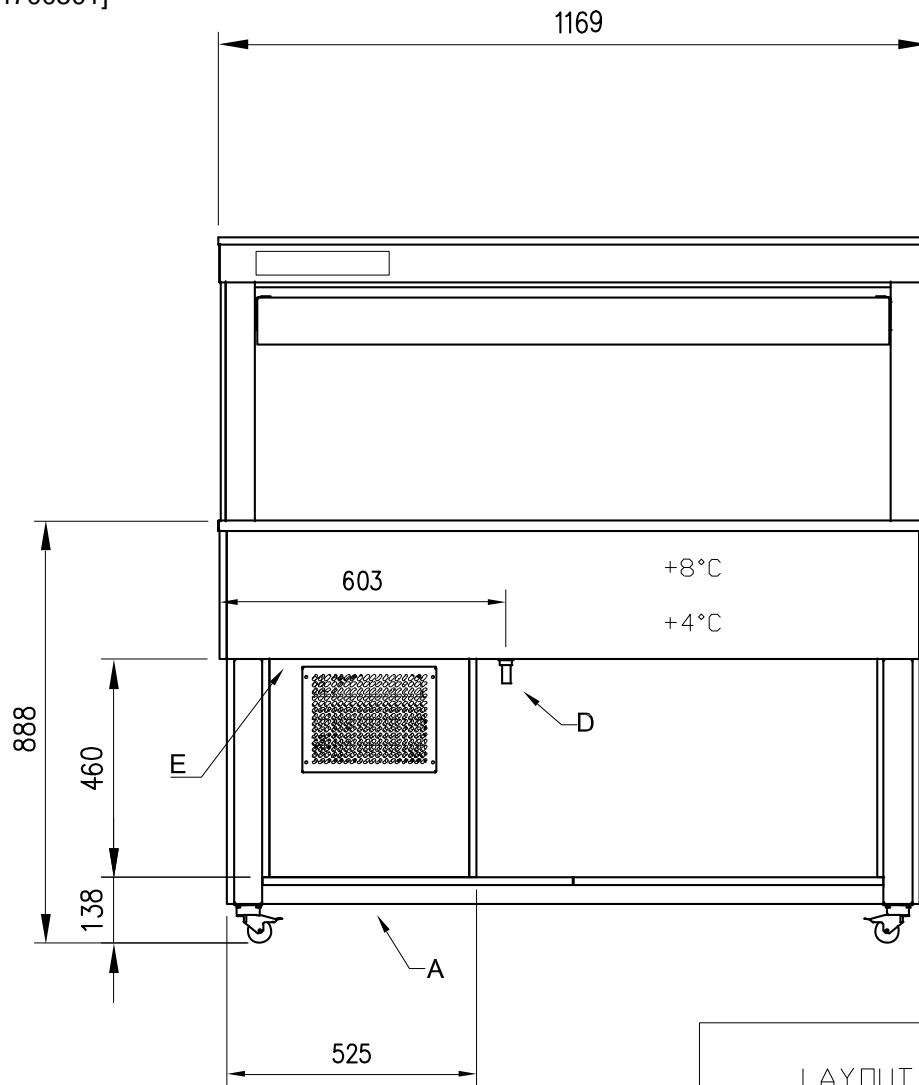