

Masszeichnung

Kühltisch (2 Abteile) KTE 2-71-2T MFL (R-290)

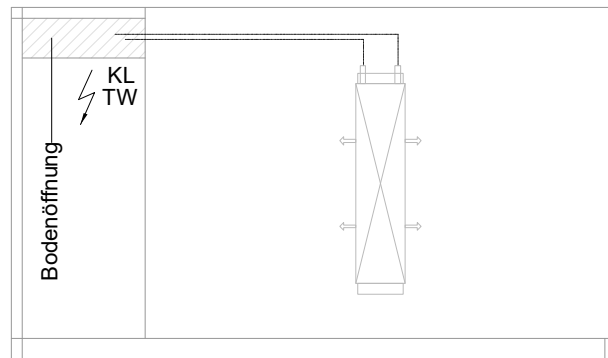
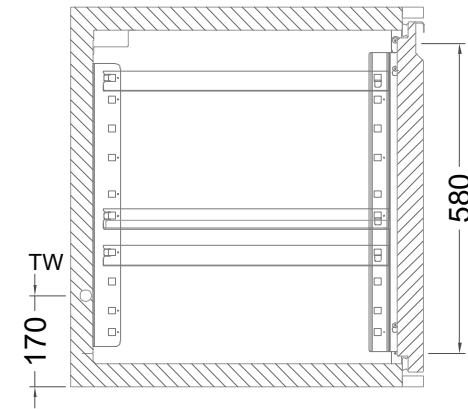
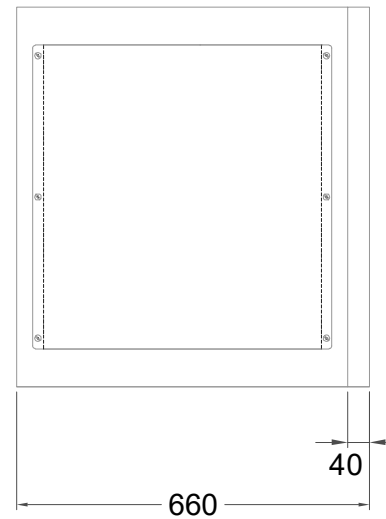
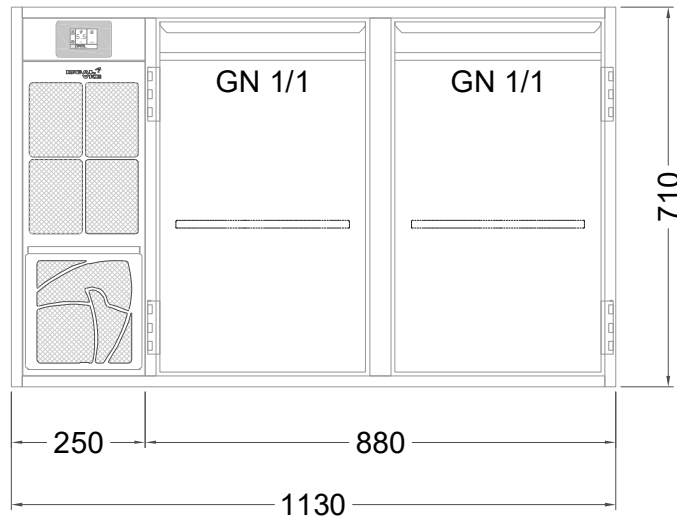

[Art.Nr.: 31000577]

KTE 2-71-2T

- * KL...Kälteleitungen
- * TW...Tauwasser - kein bauseitiger Ablauf erforderlich

Türelement

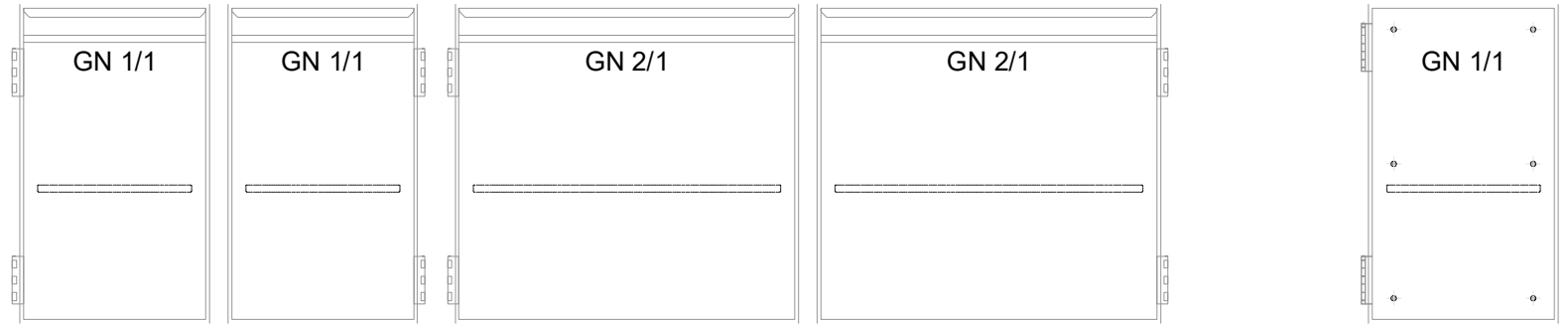
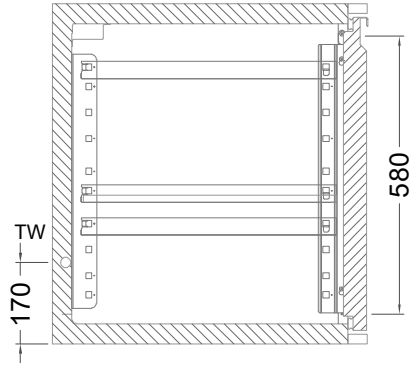

2 Züge 1/2-1/2

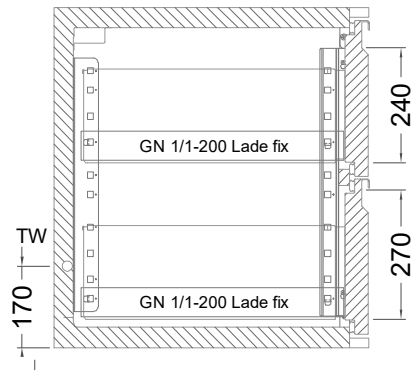

2 Züge FL (Flaschenlade)

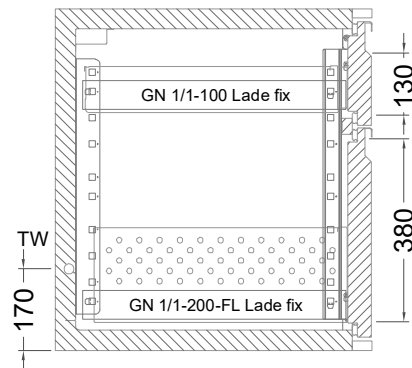

3 Züge 3x1/3

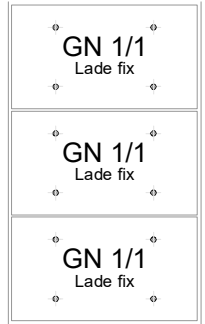
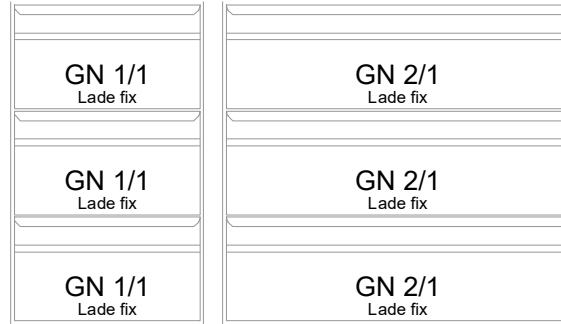
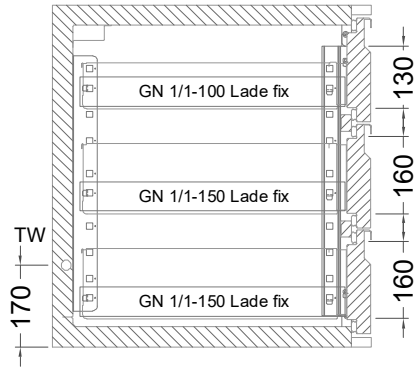

2 Züge 1/2-1/2 mit herausnehmbaren Ladeneinsätzen

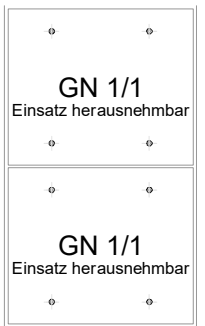
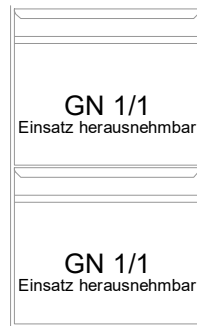
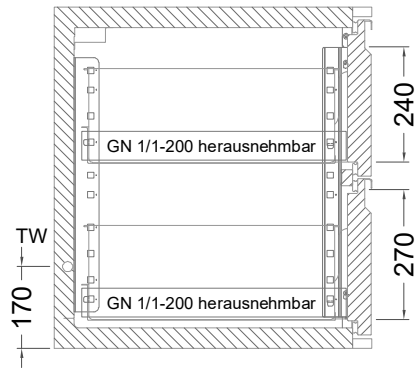

3 Züge 3x1/3 mit herausnehmbaren Ladeneinsätzen

