

Schaltplan

Impuls-Verkaufsregal CALEO COLD 60

[Artikel-Nr.: 484356600]

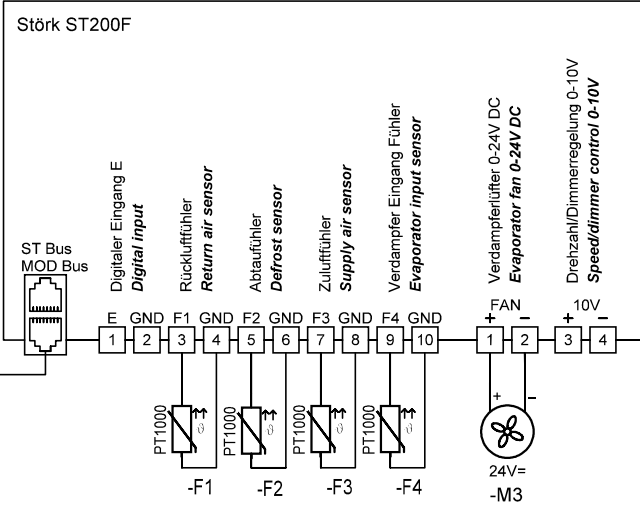

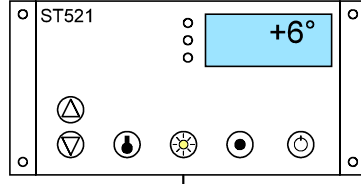

- K1 Kühlanforderung 16(6) A 230V~ Cooling request
- K2 Verflüßigerlüfter 16(1,6) A 230V~ Condenser fan
- K3 Beleuchtung 16(1,6) A 230V~ Lighting
- K4 Rahmenheizung 16(1,6) A 230V~ Frame heater
- K5 Abtauheizung 16(1,6) A 230V~ Speed/dimmer control

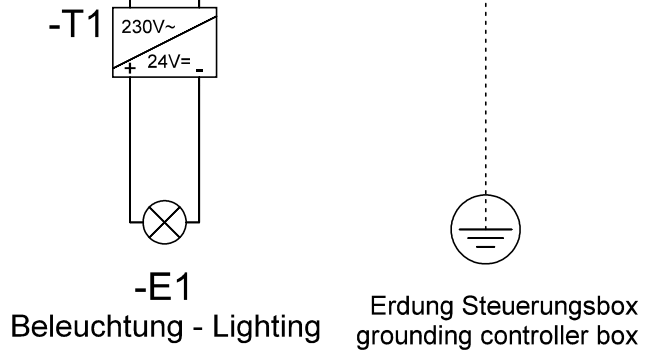
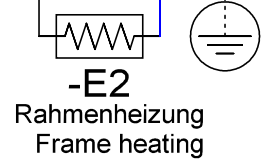
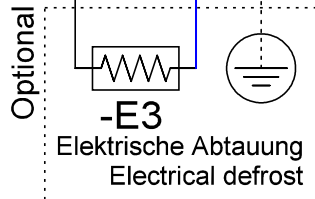
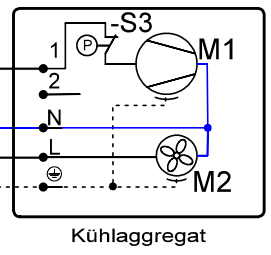
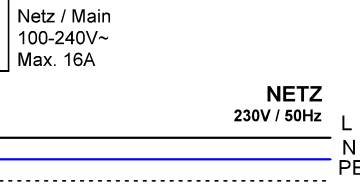
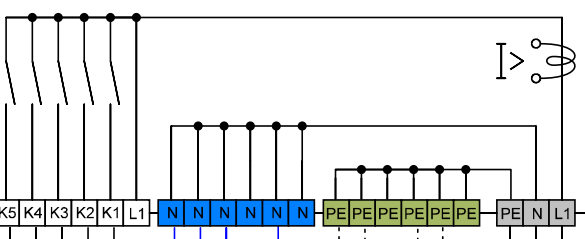

Änderungen / Changes	Datum / Date	Name	Bezeichnung / Identification	Seite / Page
	gez.: 03.02.2022	Köberl C.	Schaltplan Kühlvitrine Circuit diagram refrigerated display case	
	gepr.:			
			AB-Nr.:	



Finanzen/Service
28307 Bremen
Thalendorststraße 15
Tel.+49 421 48557-0
Fax+49 421 488650
bremen@nordcap.de

Vertrieb Ost
12681 Berlin
Wolfener Straße 32/34, Haus K
Tel.+49 30 936684-0
Fax+49 30 936684-44
berlin@nordcap.de

Vertrieb West
40699 Erkrath
Max-Planck-Straße 30
Tel.+49 211 540054-0
Fax+49 211 540054-54
erkrath@nordcap.de

Vertrieb Nord
21079 Hamburg
Großmoorbogen 5
Tel.+49 40 766183-0
Fax+49 40 770799
hamburg@nordcap.de

Vertrieb Süd
55218 Ingelheim
Hermann-Bopp-Straße 4
Tel.+49 6132 7101-0
Fax+49 6132 7101-20
ingelheim@nordcap.de



www.nordcap.de