

Ersatzteilliste-Explosionszeichnung

Neutrales Kochtresen-Element **NTEC3-3P**

[Artikel-Nr.: 406352083]



LIBERO POINT 2 E 3 POSTI LIBERO POINT 2 AND 3 PLACES

PNC	Model	Ref	Description	Brand	Modules	Voltage
351078	E2VVADBQZU	a	LIBERO POINT MOBILE COUNT-2M 1PH UNITS-U	Elux Prof	2 modules	230 V
351079	E2VVCDBQZU	b	LIBERO POINT MOBILE COUNT-3M 1PH UNITS-U	Elux Prof	3 modules	230 V
351080	E2VVADBQZA	c	LIBERO POINT MOBILE COUNTER-2M 1PH UNIT	Elux Prof	2 modules	230 V
351081	E2VVBDBQZA	d	LIBERO POINT MOBILE COUNT-2M 3PH UNITS	Elux Prof	2 modules	400 V
351082	E2VVCDBQZA	e	LIBERO POINT MOBILE COUNTER- 3M 1PH UNIT	Elux Prof	3 modules	230 V
351083	E2VVDDDBQZA	f	LIBERO POINT MOBILE COUNT-3M 3PH UNITS	Elux Prof	3 modules	400 V
351084	E2VVADBZRZA	g	LIBERO POINT REF MOB.COUNTER-2M 1PH UNIT	Elux Prof	2 modules	230 V
351085	E2VVBDBZRZA	h	LIBERO POINT REF MOB.COUNT-2M 3PH UNITS	Elux Prof	2 modules	400 V
351086	E2VVCDBZRZA	j	LIBERO POINT REF MOB.COUNTER-3M 1PH UNIT	Elux Prof	3 modules	230 V
351087	E2VVDDDBZRZA	k	LIBERO POINT REF MOB.COUNT-3M 3HP UNITS	Elux Prof	3 modules	400 V
351090	E2VVADBZRZU	m	LIBERO POINT REF MOB.COUNT-2M 1PH UNITS-	Elux Prof	2 modules	230 V
351091	E2VVCDBZRZU	n	LIBERO POINT REF MOB.COUNT-3M 1PH UNITS-	Elux Prof	3 modules	230 V
352080	Z2VVADBQZA	o	LIBERO POINT MOBILE COUNTER- 2M 1PH UNIT	Zanussi	2 modules	230 V
352081	Z2VVBDBQZA	p	LIBERO POINT MOBILE COUNT-2M 3PH UNITS	Zanussi	2 modules	400 V
352082	Z2VVCDBQZA	q	LIBERO POINT MOBILE COUNTER-3M 1PH UNIT	Zanussi	3 modules	230 V
352083	Z2VVDDDBQZA	r	LIBERO POINT MOBILE COUNT-3M 3PH UNITS	Zanussi	3 modules	400 V
352084	Z2VVADBZRZA	s	LIBERO POINT REF MOB.COUNTER-2M 1PH UNIT	Zanussi	2 modules	230 V
352085	Z2VVBDBZRZA	t	LIBERO POINT REF MOB.COUNT-2M 3PH UNITS	Zanussi	2 modules	400 V
352086	Z2VVCDBZRZA	u	LIBERO POINT REF MOB.COUNTER-3M 1PH UNIT	Zanussi	3 modules	230 V
352087	Z2VVDDDBZRZA	v	LIBERO POINT REF MOB.COUNT-3M 3HP UNITS	Zanussi	3 modules	400 V

Index

Front Side/Fronte	2
Front Panel/Panelli frontali	3
Back Panel/Panelli Posteriori	4
Compressor Drawer/Compressore e Cassetto	5
Spare parts list/Lista parti di ricambio	6

Page

2
3
4
5
6

Bold=last change / Grassetto =ultima modifica

Rev. 1

From Ser. Nr.... Up to Ser. Nr....	Ed. 2021-03 Updated 2021/10	Page: 1	Doc No:59785XT00
---------------------------------------	--------------------------------	---------	-------------------------

FRONT SIDE

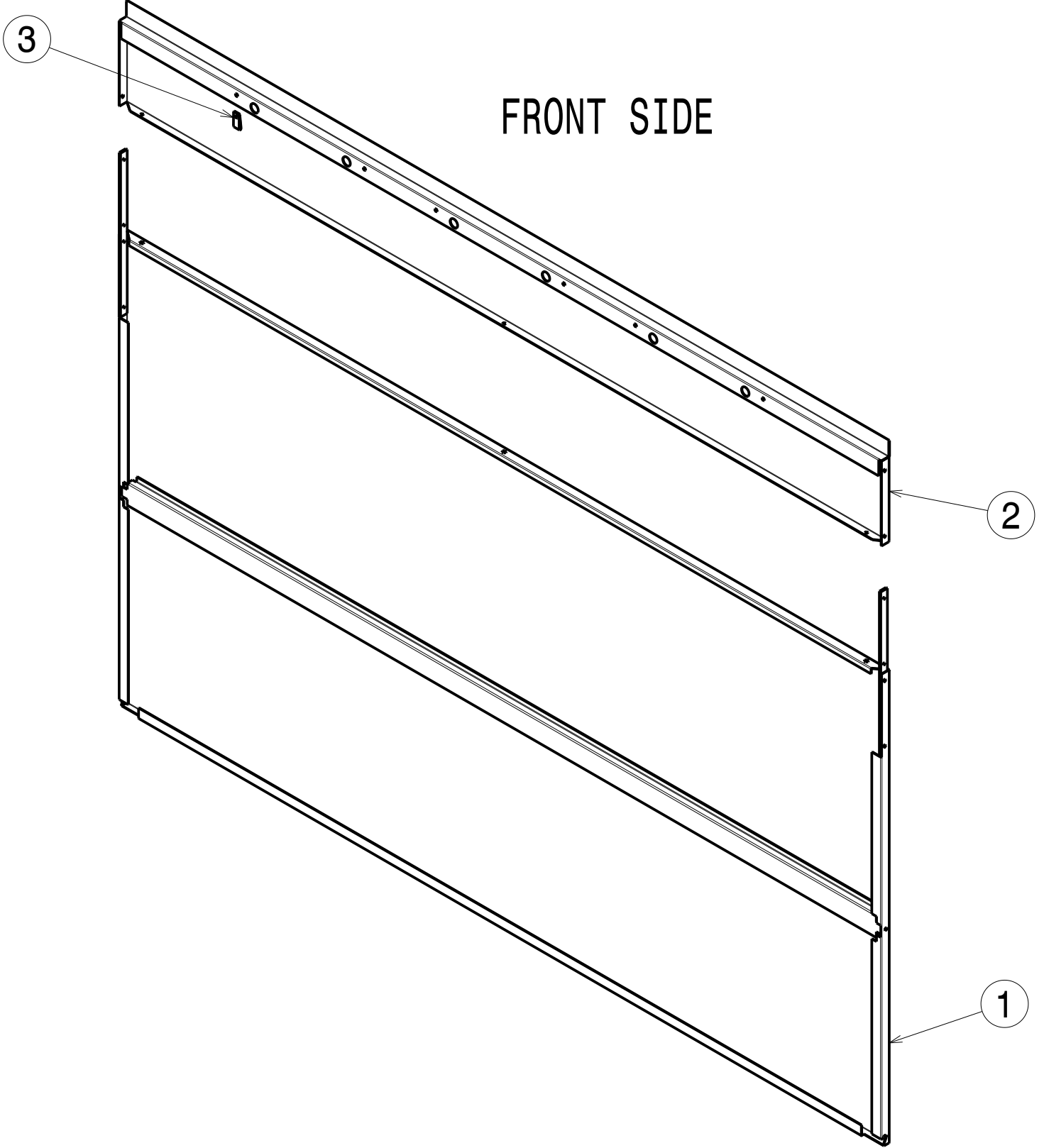

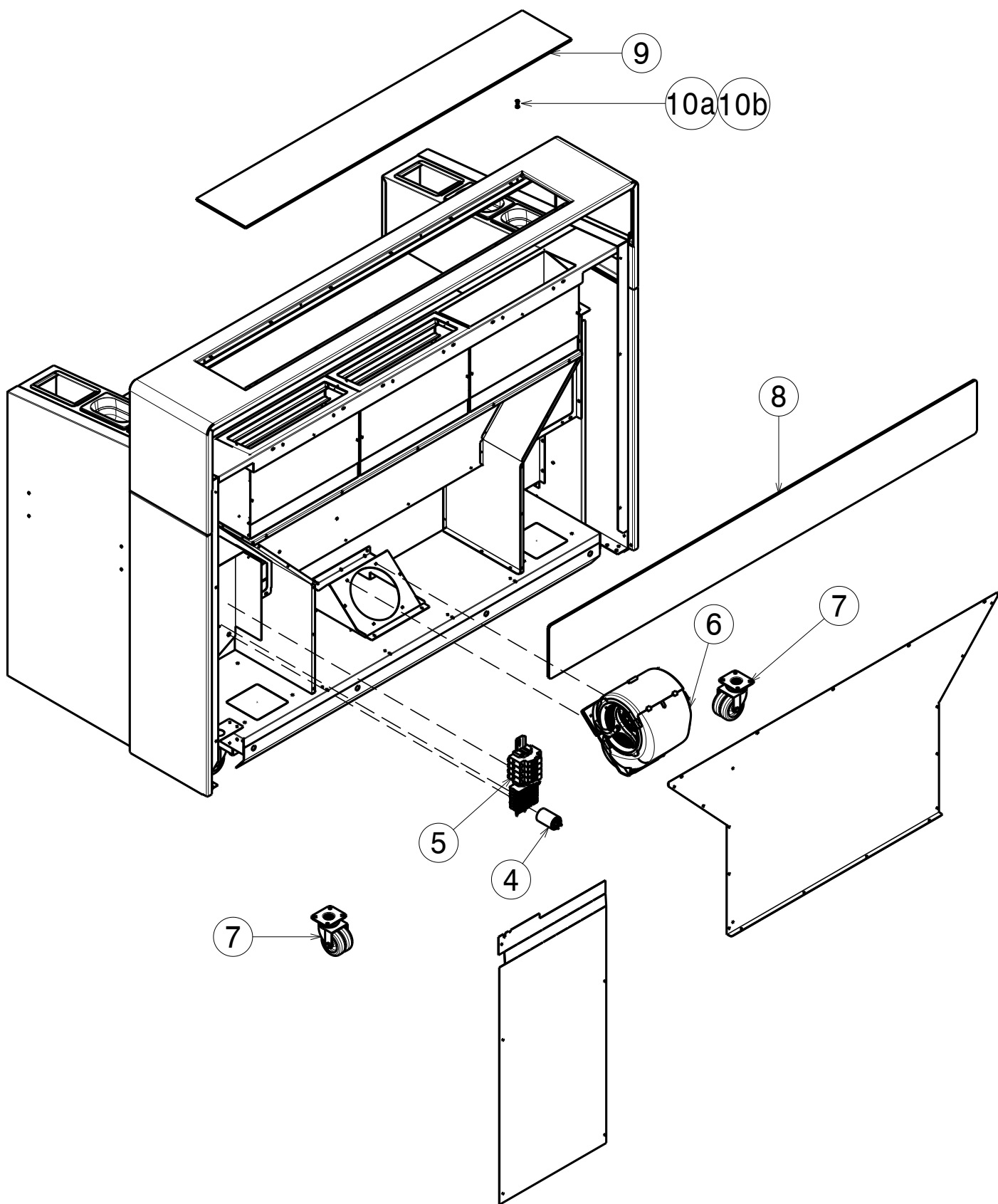

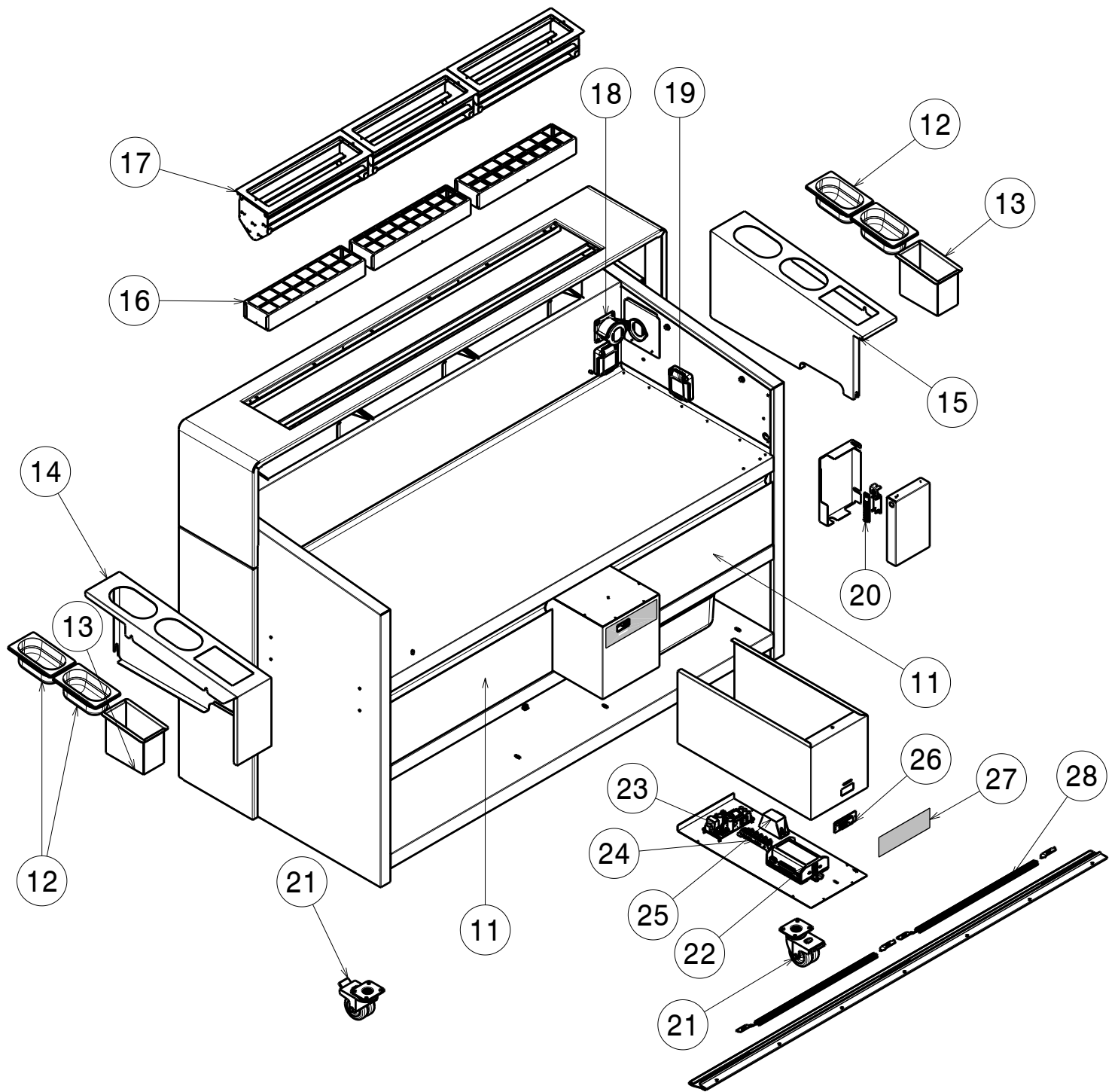

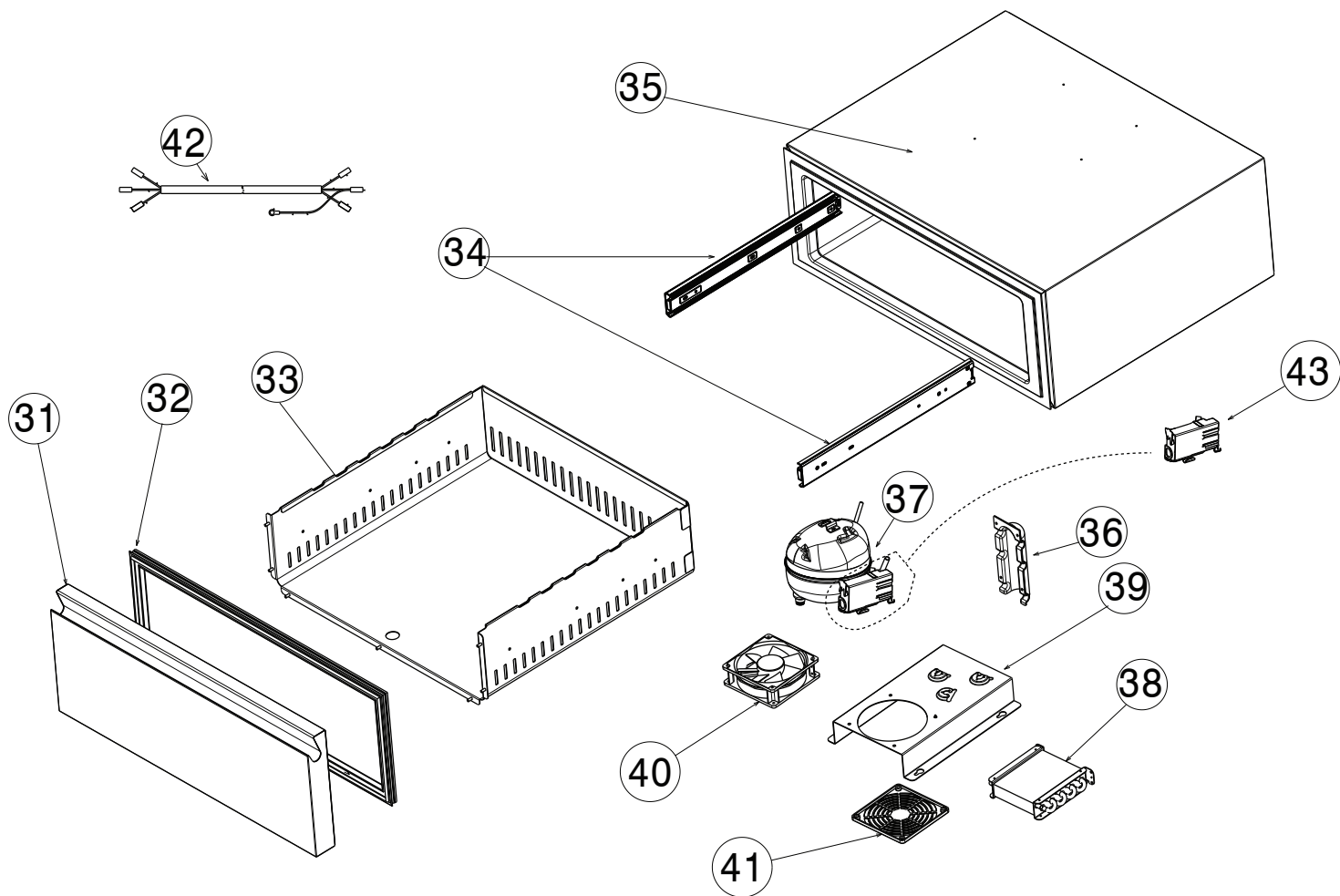

LIBERO POINT 2 E 3 POSTI
LIBERO POINT 2 AND 3 PLACES

Pos	Spare part Code	Factory Code	Descrizione	Description	V	W & T	Ref./Notes
1	0CB974	50589MC02	PANNELLO INFERIORE	2M BOTTOM PANEL 2M			a c d g h m o p s t
1	0CB975	50089D402	PANNELLO INFERIORE 3M	BOTTOM PANEL 3M			b e f j k n q r u v
2	0CB976	50589MD03	PANNELLO SUPERIORE 2M	ELUX UPPER PANEL 2M ELUX			a c d g h m
2	0CB977	50589MQ03	PANNELLO SUPERIORE 3M	ELUX UPPER PANEL 3M ELUX			b e f j k n
2	0CB978	50589NU01	PANNELLO SUPERIORE 2M ZAN	UPPER PANEL 2M ZAN			o p s t
2	0CB979	50589NT01	PANNELLO SUPERIORE 3M ZAN	UPPER PANEL 3M ZAN			q r u v
3		219301X00	PIASTRINA DOPPIA, RDP	DOUBLE PLATE, RDP		X	
4	059078	694502400	FILTRO LC	LC FILTER	X		
5	0CB984	639813L00	MORSETTIERA MONOFASE	SINGLE-PHASE TERMINAL BLOCK	X	X	230 V
5	0CB985	639813M00	PRESE MISTE	MIXED SOCKET	X	X	400 V
6	0CB980	682800700	VENTILATORE EBM D3	FAN EBM D3	X		
7	0CB998	83587AJ00	RUOTA SENZA FRENO	WHEEL WITHOUT BRAKE	X	X	
8	0CB994	574820D02	VETRO FRONTALE 3M	FRONT GLASS 3M		X	b e f j k n q r u v
8	0CB995	574820G02	VETRO FRONTALE 2M	FRONT GLASS 2M		X	a c d g h m o p s t
9	0CB996	574820F02	VETRO SUPERIORE 3M	UPPER GLASS 3M		X	b e f j k n q r u v
9	0CB997	574820H02	VETRO SUPERIORE 2M	UPPER GLASS 2M		X	a c d g h m o p s t
10a	0CB075	546400S00	RIVETTO	RIVET		X	
10b	0CB990	543845600	RONDELLA	WASHER		X	
11		835879P00	CASSETTO REFRIGERATO	REFRIGERATED DRAWER			
12	0G4461	509806C00	BACINELLA GN1/9	BUCKET GN1/9		X	
13	0CB988	5038AM601	BACINELLA PORTA UTENSILI	TOOL TRAY		X	
14	0CB992	83089QA01	PORTA BACINELLE SINISTRA	BUCKET HOLDER LEFT SIDE			
15	0CB993	50289HF03	PORTA BACINELLE DESTRA	BUCKET HOLDER RIGHT SIDE			
16	0CB927	83089NX02	FILTRO CARBONI ATTIVI	ACTIVE CARBON FILTER		X	
17	0CB928	50089CF01	FILTRO GRASSI	FAT FILTER		X	
18	0CB986	699802J00	PRESA INCASSO 3PH+N+T	EMBEDDED SOCKET 3PH+N+GRD		X	400 V
19	0CB439		SCATOLA + PRESA SHUKO	SHUKO ELECTRIC SOCKET BOX			
19	0CBAD6		SCATOLA + PRESA UK	UK ELECTRIC SOCKET BOX			
20	0CB981	657800B00	SCHEDA RICEVENTE IR-HTH	RECEIVER CARD			
21	0CB999	83587AK00	RUOTA CON FRENO	WHEEL WITH BRAKE	X	X	
22	0CB983	646817P02	TERMOREGOLATORE	THERMOREGULATOR	X		
23	095639	648R10000	ALIMENTATORE 12V, 30W	BOARD POWER SUPPLY 12V, 30W			
24	058613	A05714000	MORSETTIERA	TERMINAL BLOCK	X	X	
25	0CB989	694806400	FILTRO INDUTTORE	INDUCTOR FILTER			
26	0CB982	673800Z00	SCHEDA ELETTRONICA	CIRCUIT BOARD	X		
27	0CB991	541813T01	MEMBRANA TASTI E CONNET. LP	KEY MEMBRANE AND LP CONNEC.	X	X	
28	0CK082	805407P02	BARRA LED X PORTE	LED BAR FOR DOORS		X	
31	0CB950	50089H900	FRONTALE CASSETTO	DRAWER FRONT			
32	0CB951	543845700	GUARNIZIONE PORTA	DOOR GASKET	X	X	
33	*		CASSETTO FRIGO	FRIDGE DRAWER			
34	0CB952	83587AH00	GUIDE CASSETTO	DRAWER GUIDES	X	X	
35	0CB961	83089QL00	CASSA COIBENTATA	INSULATED CASE			
36	*		COPERTURA TUBO EVAPORAZIONE	EVAPORATION TUBE COVER			
37	0CB953	684800000	COMPRESSORE	COMPRESSOR	X		
38	0CB954	83089QM00	CONDENSATORE	CONDENSER	X		
39	*		SUPPORTO COMPRESSORE	COMPRESSOR SUPPORT			
40	0CB955	682800800	VENTOLA 240V	FAN 240V	X		
41	0CB956	51489H800	GRIGLIA PROTEZIONE	PROTECTION GRID			
42	0CB962	632806C00	CAVO ALIMENTAZIONE	POWER CABLE	X		
43		657800F00	KLIXON CON COPERTURA	KLIXON WITH COVER	X		

Finanzen/Service

28307 Bremen
Thalenhorststraße 15
Tel.+49 421 48557-0
Fax+49 421 488650
bremen@nordcap.de

Vertrieb Ost

12681 Berlin
Wolfener Straße 32/34, Haus K
Tel.+49 30 936684-0
Fax+49 30 936684-44
berlin@nordcap.de

Vertrieb West

40699 Erkrath
Max-Planck-Straße 30
Tel.+49 211 540054-0
Fax+49 211 540054-54
erkrath@nordcap.de

Vertrieb Nord

21079 Hamburg
Großmoorbogen 5
Tel.+49 40 766183-0
Fax+49 40 770799
hamburg@nordcap.de

Vertrieb Süd

55218 Ingelheim
Hermann-Bopp-Straße 4
Tel.+49 6132 7101-0
Fax+49 6132 7101-20
ingelheim@nordcap.de



www.nordcap.de