

Schaltplan

Kombinationsvitrine KGU GR-152-70-Z

[Art. 484535266]

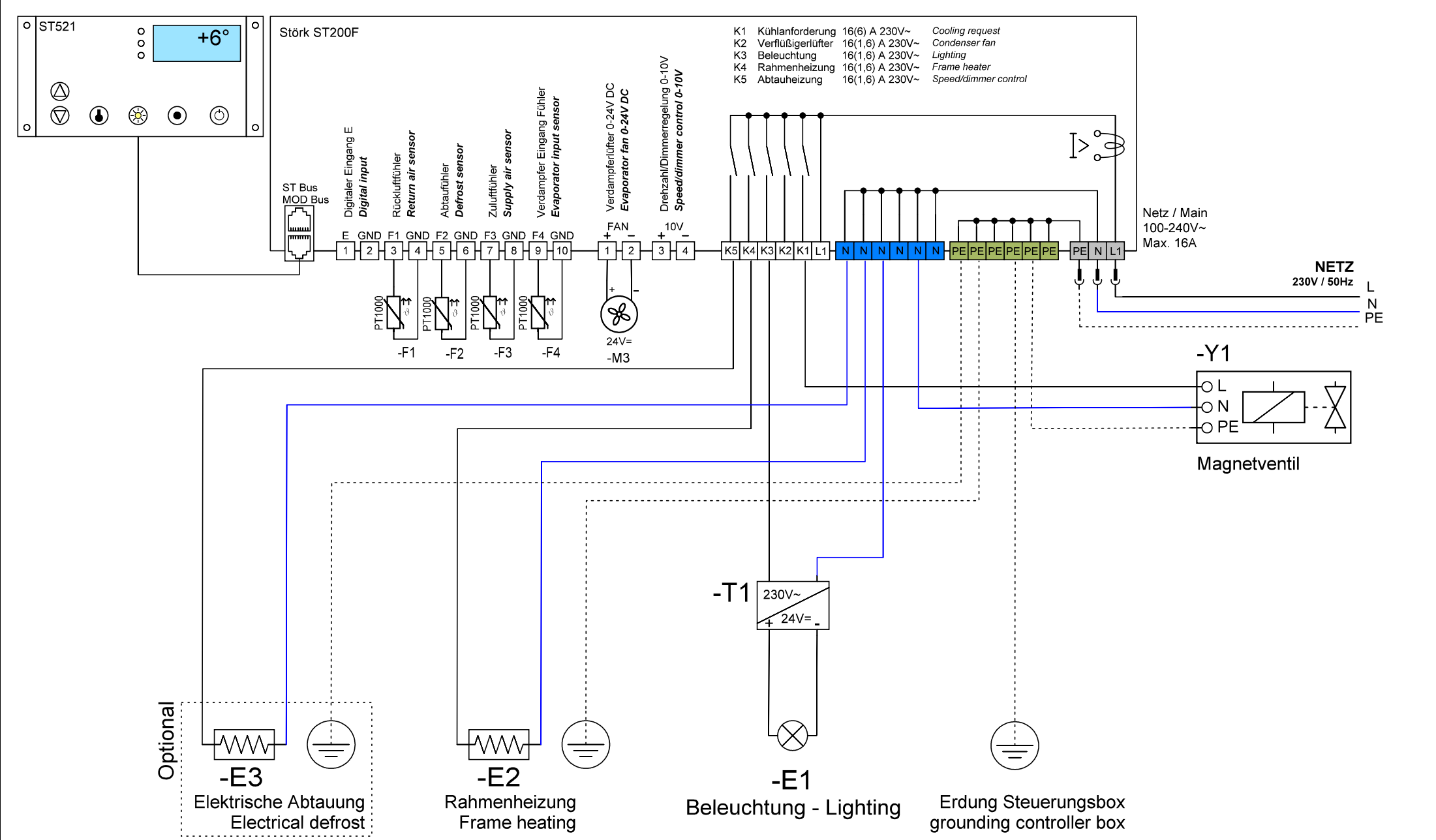



| Änderungen / Changes | Datum / Date | Name | Bezeichnung / Identification | Seite / Page |
|----------------------|--------------|-----------|---|--------------|
| gez.: | 03.02.2022 | Köberl C. | Schaltplan Kühlvitrine <i>Circuit diagram refrigerated display case</i> | |
| gepr.: | | | | |
| | | | AB-Nr.: | |

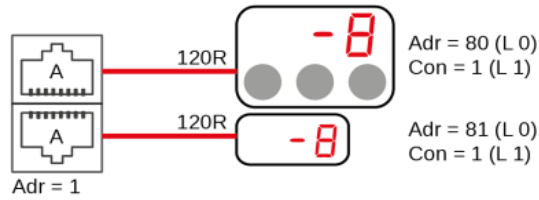
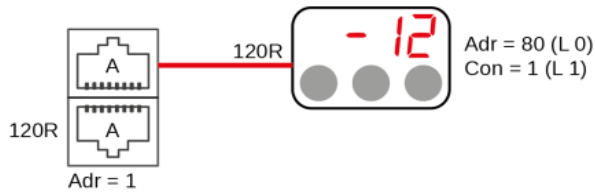

1x RS485 (A)

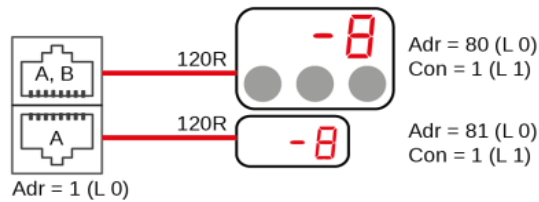
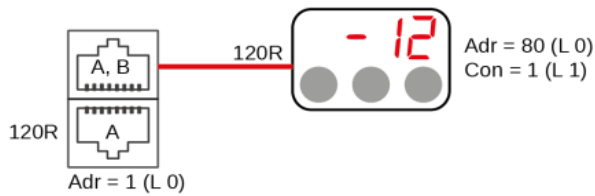

2x RS485 (A, B)

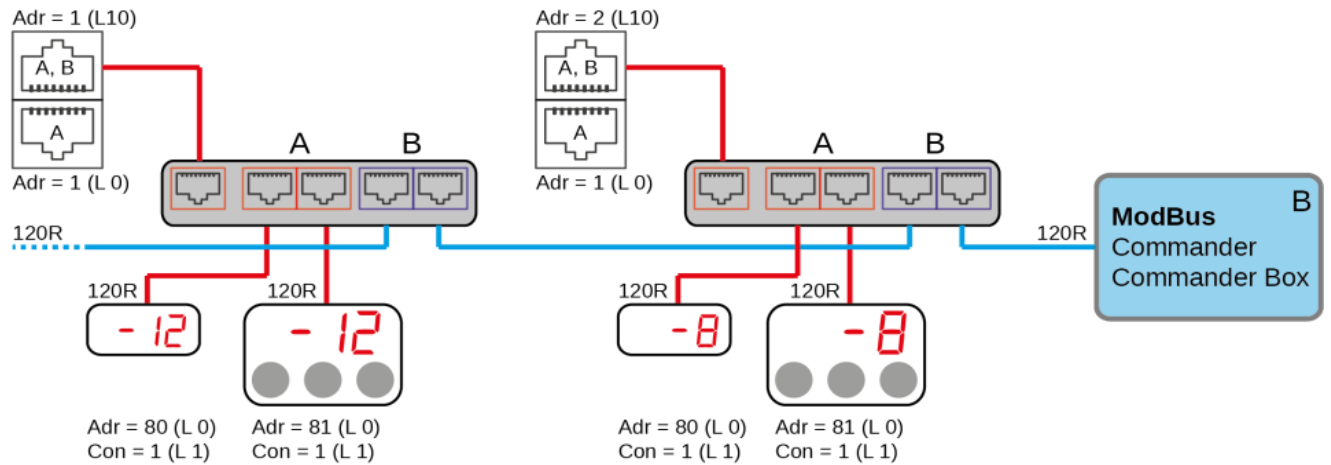
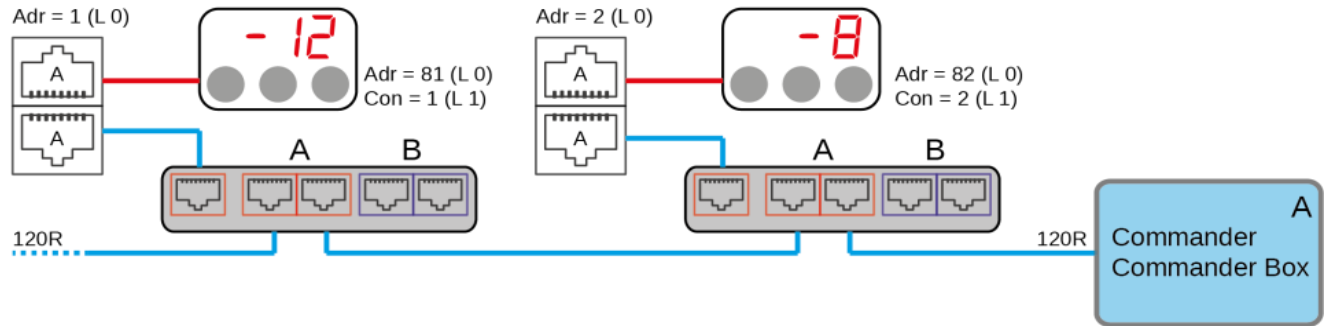
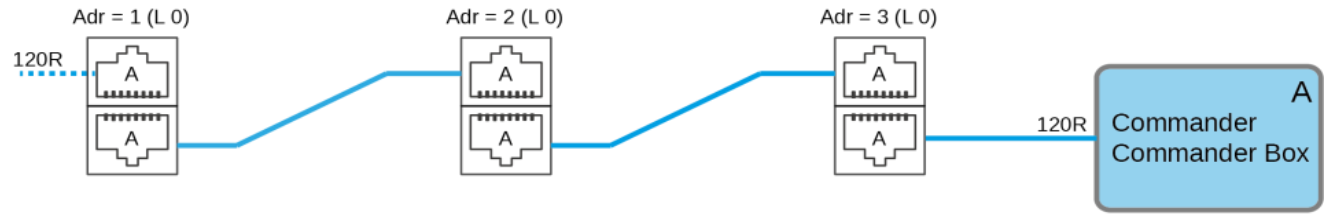

Finanzen/Service
28307 Bremen
Thalendorststraße 15
Tel.+49 421 48557-0
Fax+49 421 488650
bremen@nordcap.de

Vertrieb Ost
12681 Berlin
Wolfener Straße 32/34, Haus K
Tel.+49 30 936684-0
Fax+49 30 936684-44
berlin@nordcap.de

Vertrieb West
40699 Erkrath
Max-Planck-Straße 30
Tel.+49 211 540054-0
Fax+49 211 540054-54
erkrath@nordcap.de

Vertrieb Nord
21079 Hamburg
Großmoorbogen 5
Tel.+49 40 766183-0
Fax+49 40 770799
hamburg@nordcap.de

Vertrieb Süd
55218 Ingelheim
Hermann-Bopp-Straße 4
Tel.+49 6132 7101-0
Fax+49 6132 7101-20
ingelheim@nordcap.de



www.nordcap.de