

# Masszeichnung Einbaukühlwanne EURO 1-E

[Art. 484253751]

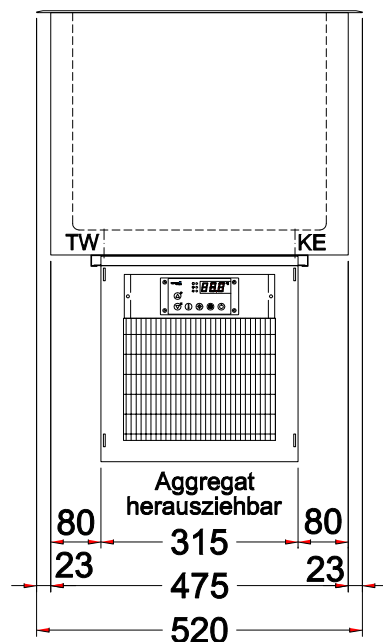

(Bedienseite)

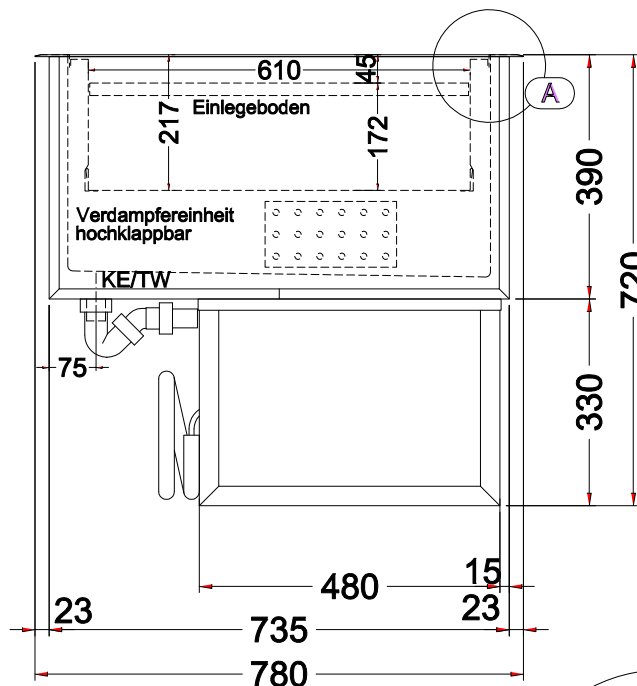

(Seitenansicht)

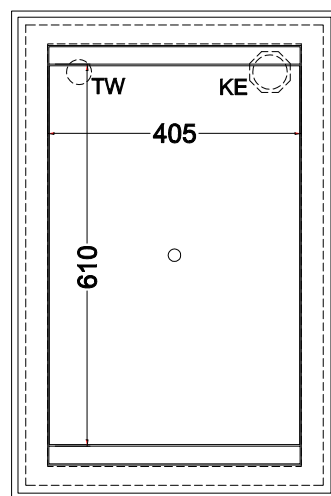

(Draufsicht)

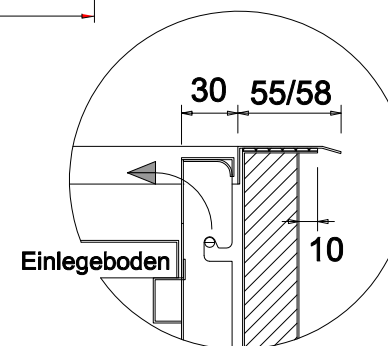

Detail A:

TW = Tauwasserablauf DNØ30  
KE = Kälte-Elektro