

Masszeichnung Einbaukühlvitrine EPV 80-5 Front geschlossen

[Art. 484357000]

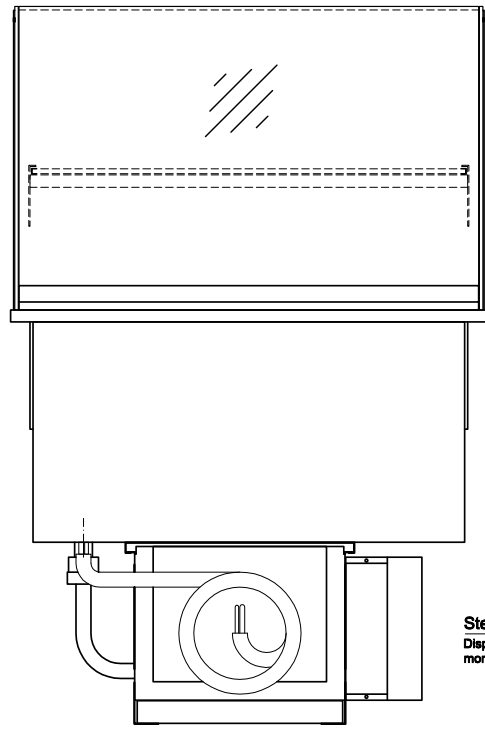

(Kundenseite)

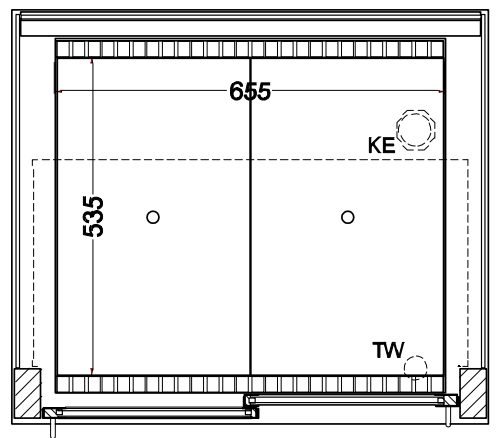
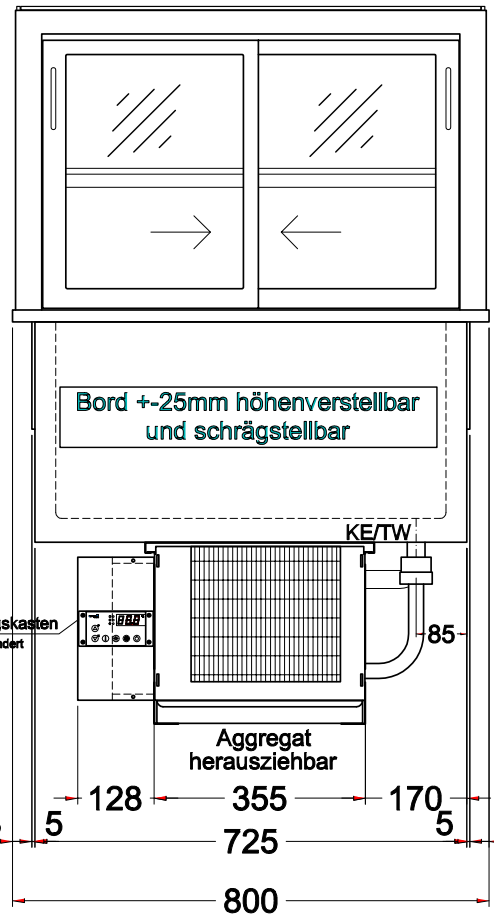

(Grundriss)

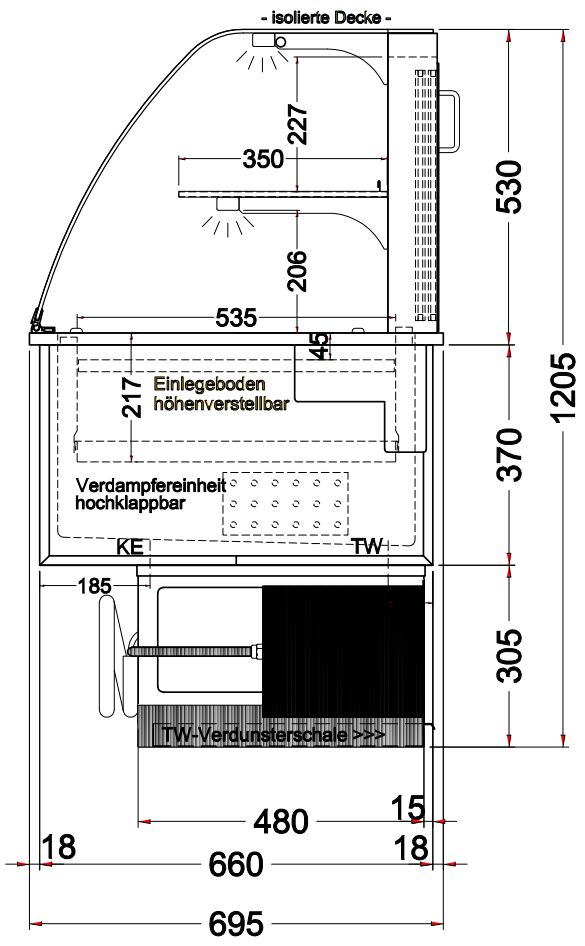

TW = Tauwasserablauf DNØ30
KE = Kälte-Elektro