

# Masszeichnung

## Backwarenkühltisch BKE 2-76-2T MFL (R-290)

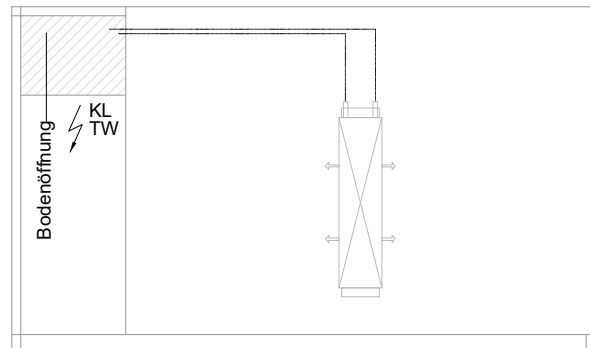
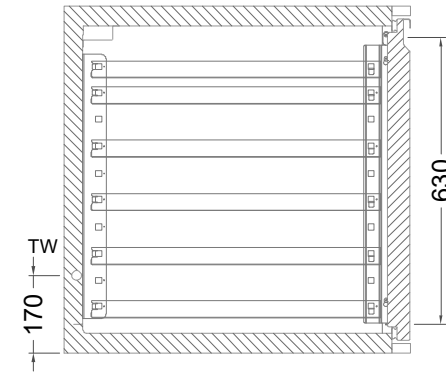
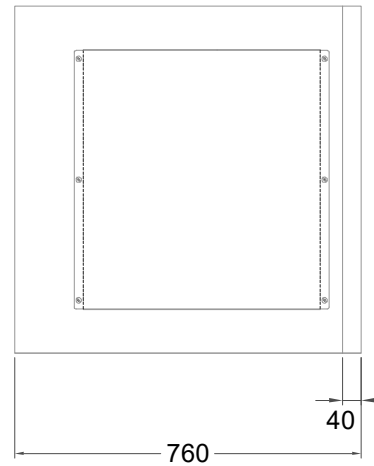

[Art.Nr.: 31000691]

**BKE 2-76-2T**

- \* KL...Kälteleitungen
- \* TW...Tauwasser - in der Rückwand geführt, selbstständige Verdunstung über Aggregatabwärme, kein bauseitiger Ablauf erforderlich
- \* ⚡ Elektroanschluss