

Masszeichnung

Einbaukühlvitrine BAK 92-53-E

[Artikel-Nr.: 484357201]

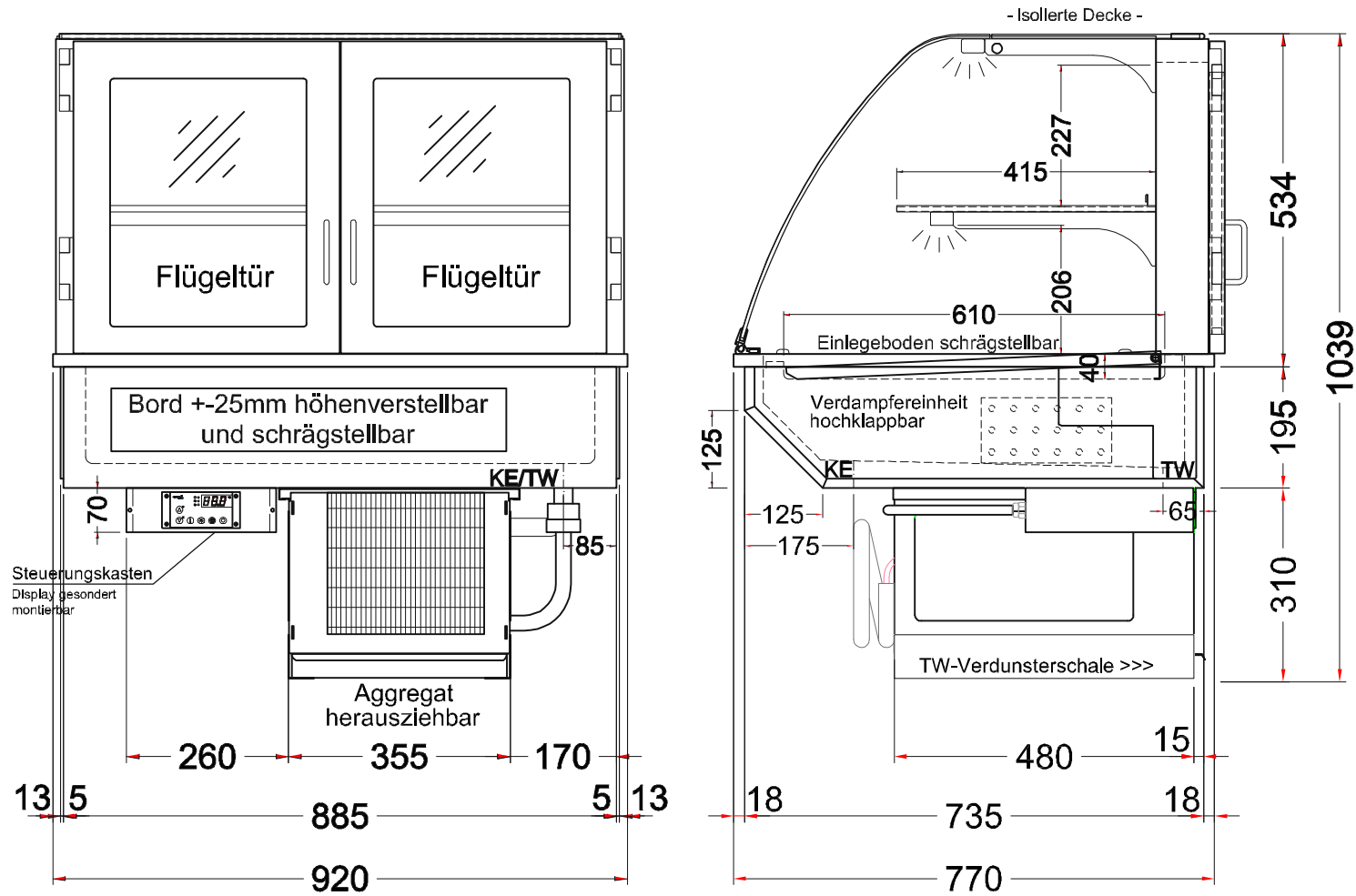

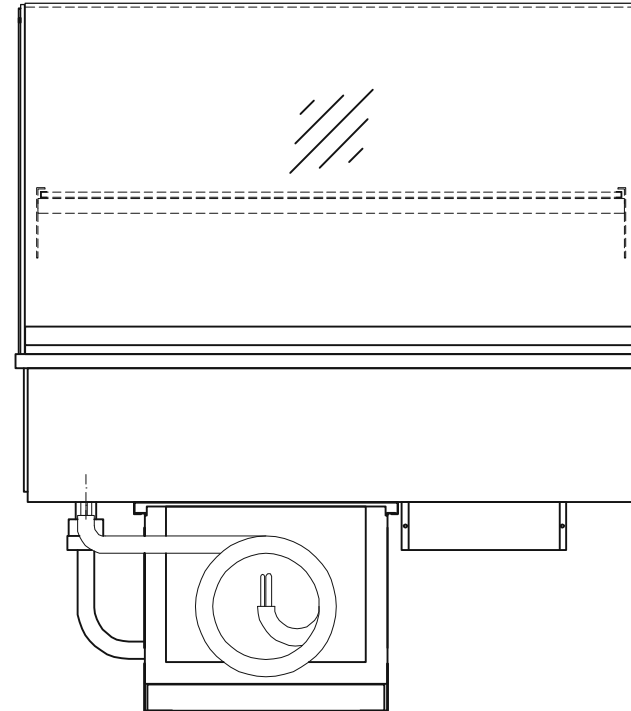
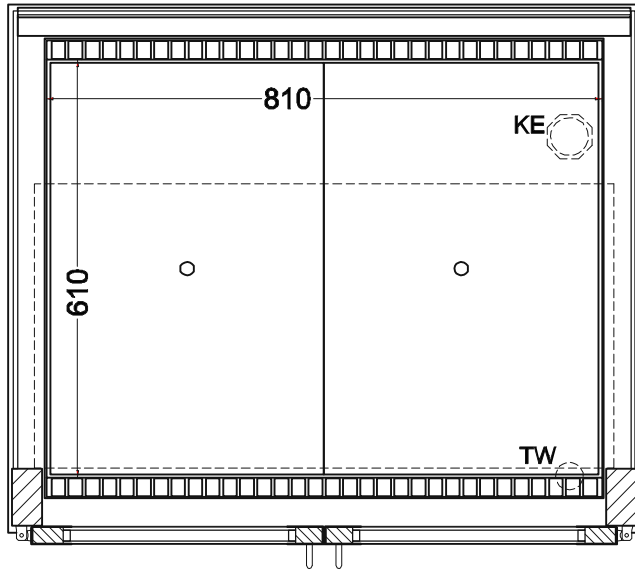

Bord +/-25mm höhenverstellbar
und schrägstellbar

TW = Tauwasserablauf DNØ30
KE = Kälte-Elektro

