

Masszeichnung

Backwarenkühltisch UBKE 4-56-4T MFR (R-290)

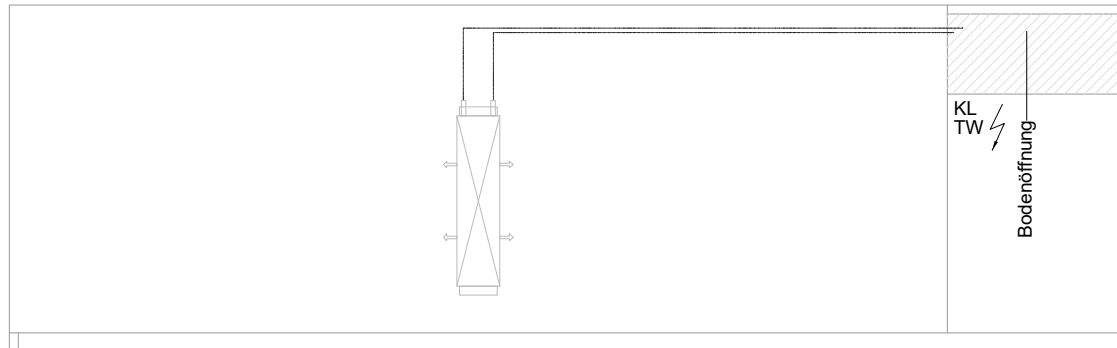
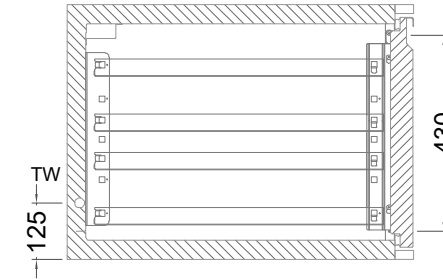
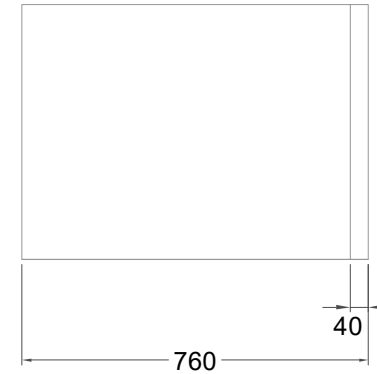

[Art.Nr.: 31000710]

UBKE 4-56-4T

- * KL...Kälteleitungen
- * TW...Tauwasser - in der Rückwand geführt, selbstständige Verdunstung über Aggregatabwärme, kein bauseitiger Ablauf erforderlich
- * ⚡ Elektroanschluss