

# Masszeichnung

## Elektro-Fritteuse EVO 900 EF9 / 1B-18L-U1FT-S

[Art. 406392094]

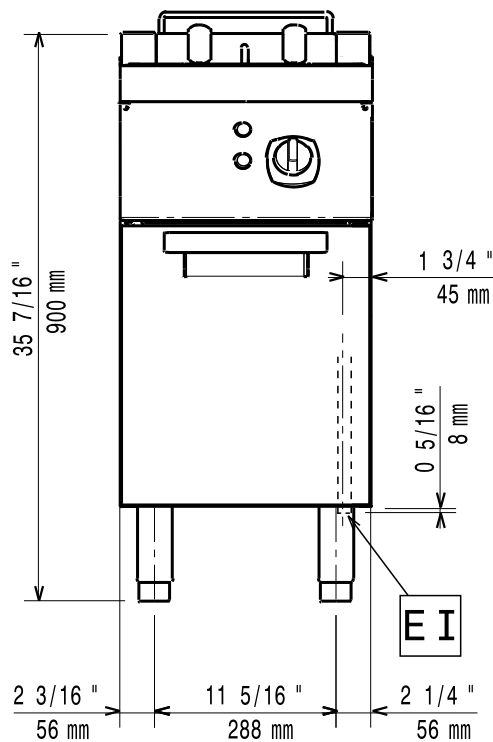

[Vorderansicht]

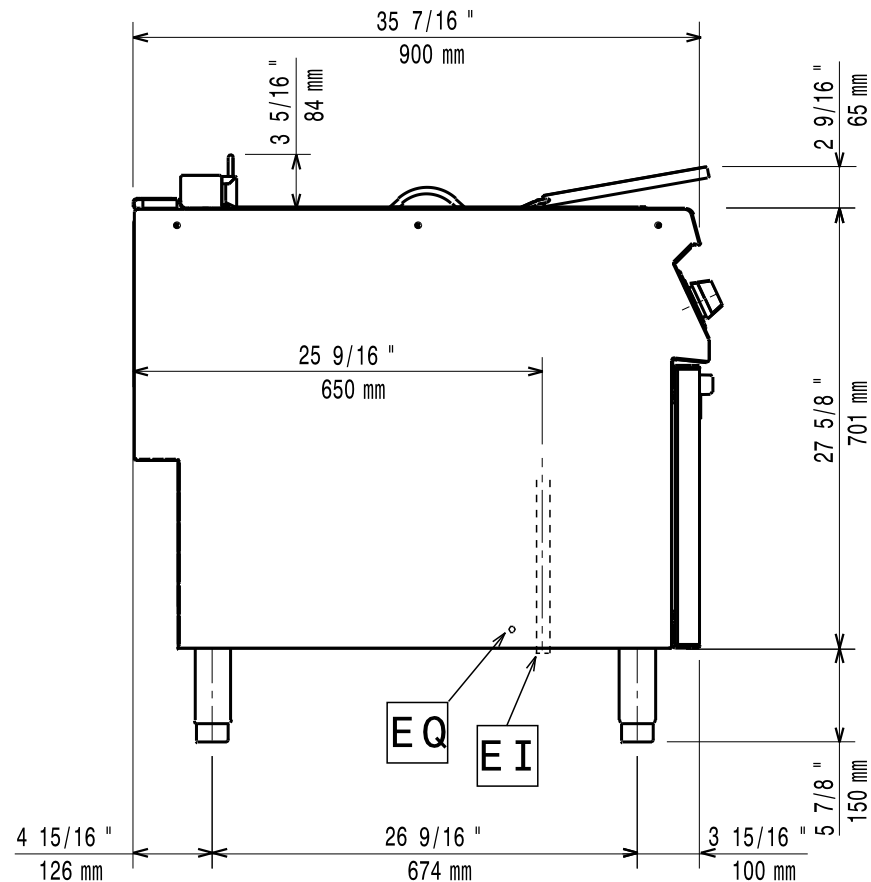

[Seitenansicht]

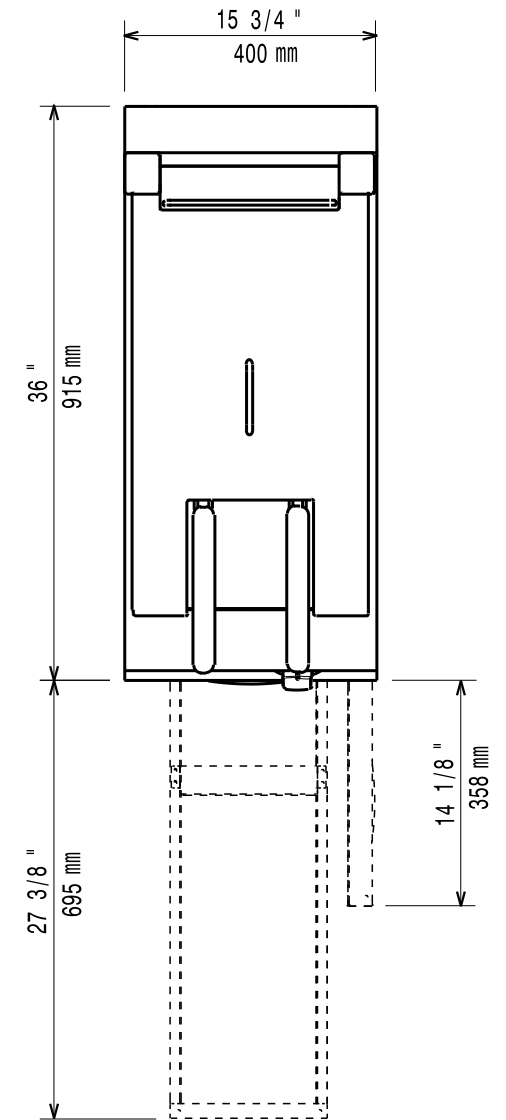

[Draufsicht]